



Battery chargers

Inverter-chargers

Battery monitoring



Engineered power

Inverters

Battery splitters

Battery separators

MPPT solar charge controllers

DC/DC converters

SWISS made power

Summary

The company	3
Applications	6
- Applications in remote areas	6
- Mobile applications	8
- Backup applications	10
- Self-consumption systems	12
Products	14
- MPPT solar charge controllers	14
- Sine wave inverter-chargers	18
- Sine wave inverters	28
- Battery chargers	30
- DC/DC converters	31
- Battery splitters	32
- Battery separators	32
- Battery protection	33
- Battery monitoring	33
Appendices	34
- Technical data	36
- How to find us	44

Studer Innotec was established in 1987, not as a result of market research, but founded on my wish to improve solar systems. Therefore it was natural to focus on the main component of a battery system: the inverter.

Three years later the company was manufacturing its first inverter models, eight years later it started to export them and then gradually opened up to new application areas (mobile applications, backup systems and industrial applications).

Today Studer Innotec provides an extensive product range with over 60 products that assure storage, conversion and management of energy, of which over 95% are exported through our distributor network with over 100 partners worldwide.

The key success factor in maintaining our competitive lead is constant innovation. Through its know-how and experience, Studer Innotec ensures the renewal of its product range as well as expanding into new applications such as self-consumption systems and mini-grids.

Our company's vision is the same as at its beginnings: more than a product, we offer innovative solutions to optimise any solar system whatever the application. These solutions are designed and manufactured at the same location, in Sion, Switzerland, as a result of the close collaboration and interaction with our customers.

Roland Studer
 Founder and CEO of Studer Innotec SA

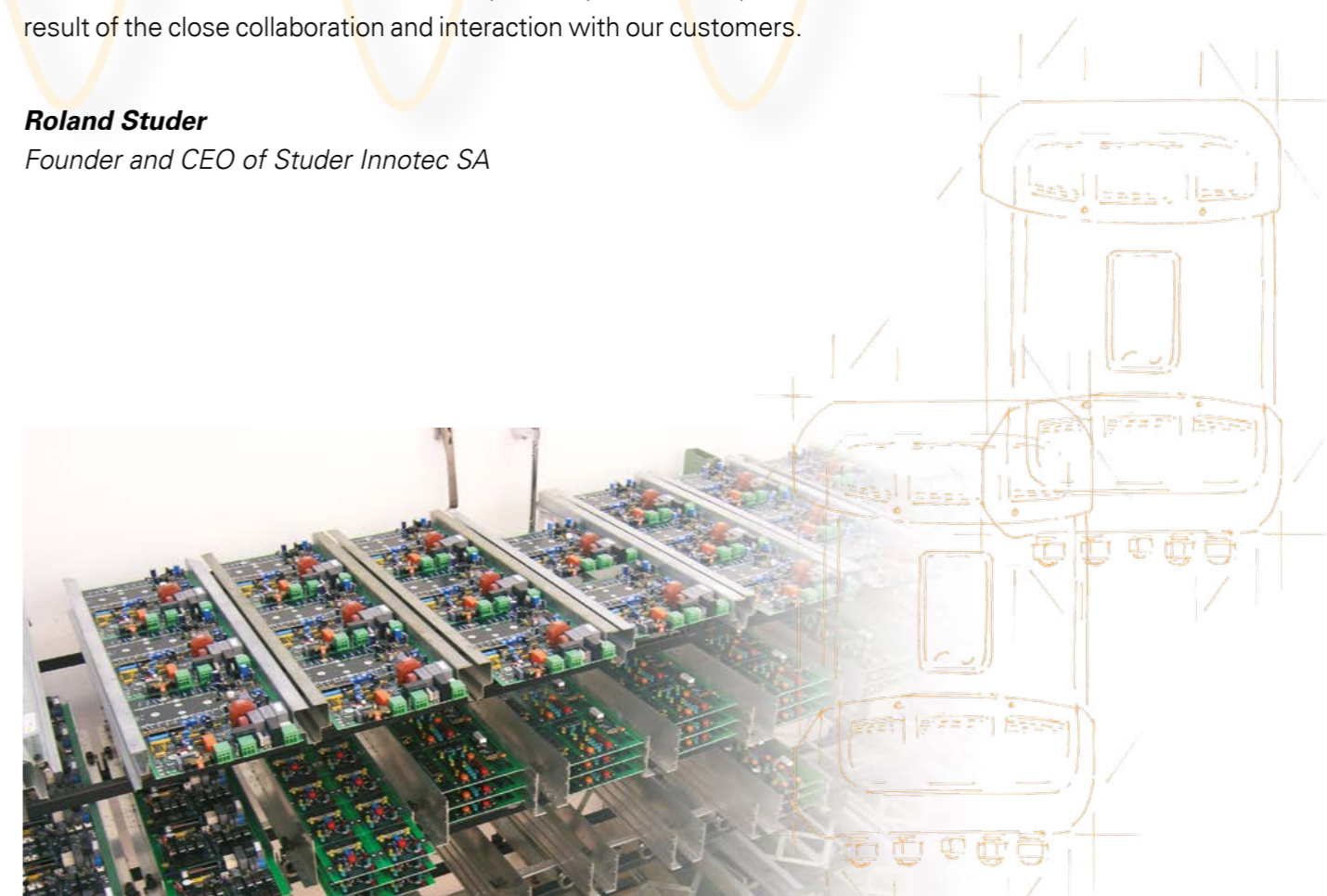

Photos credits
 Robert Hofer, Céline Ribordy: Studer's products; EB techniek/De Hoeve: p. 8; Hacksss-Fotolia.com: p. 10; Getek AS: p. 24; Meteorisk: p. 3, 44; Perspective: p. 5, 30; SEI AG: p.12; Siblik: p. 29; Solarni Panely: p. 20; Steca: p. 6 bottom; Studer Innotec SA: p. 15, 19.

Graphism
 Atelier Perspective, R. Gigon, Sion.
 July 2015



Production integration and flexibility

Studer Innotec's company philosophy has always been to master the complete process: from development to product sales. That is why Studer Innotec since its beginning is a vertically integrated company, capable of far greater flexibility than its competitors. Furthermore it has a team of 13 Research & Development engineers fully dedicated to turn the market expectations into products and services.

The performance choice

In order to comply with Studer Innotec's high-tech product concept including outstanding performance and reliability, the company choose its components with greatest care. This is the reason why Studer Innotec has selected the latest technologies; such as digital signal processors (DSP) that provide higher efficiency to its inverters.

Quality without compromise

Studer Innotec is an ISO enterprise that develops and manufactures its products entirely in Switzerland. It also upholds its commitment to an efficient and sustainable energy environment supplying to the market high quality products.



Ease in use and product versatility

Quality choice will continue to guide Studer Innotec's strategic axis towards the future. Beyond performance, the next inverters will have increased ease of use and will offer greater versatility to the users.

Proximity with clients

From research to commercialisation, Studer Innotec endeavours to carry on its human and financial investments in order to keep its lead in terms of global offer and proximity with clients. This closeness is maintained by a network of distributors and qualified service partners. Partner addresses can be found on the company website, under « Distributors ».

In order to offer its partners an in-depth knowledge of its products and guarantee high end support, Studer Innotec organizes twice a year trainings called Studer Qualidays. Taking place over two to three days, depending on the modules chosen, Qualidays is also a remarkable opportunity for participants to share experiences with each other.

The Qualidays are organised in the heart of the Swiss Alps in Sion, at Studer Innotec's Headquarter and manufacturing centre.

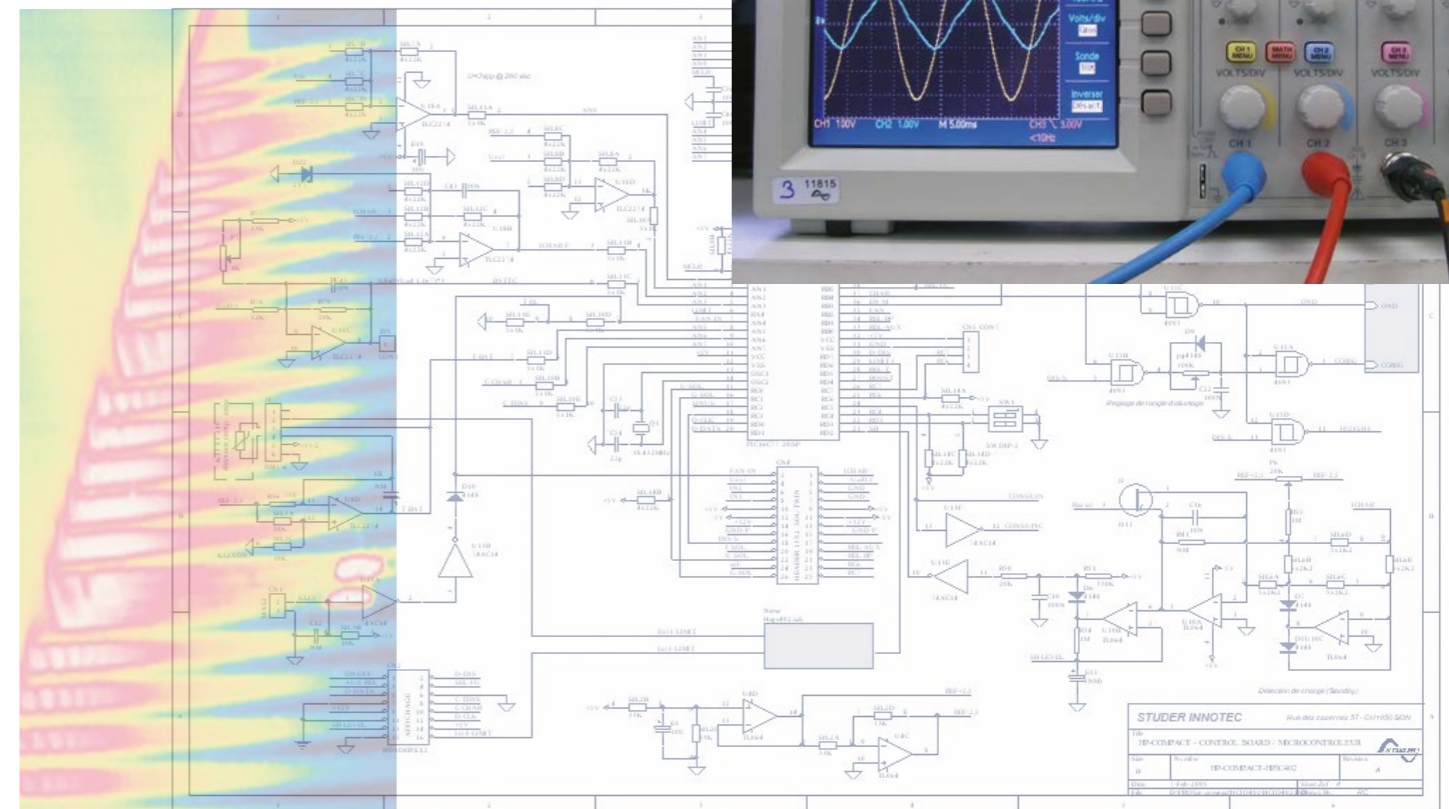
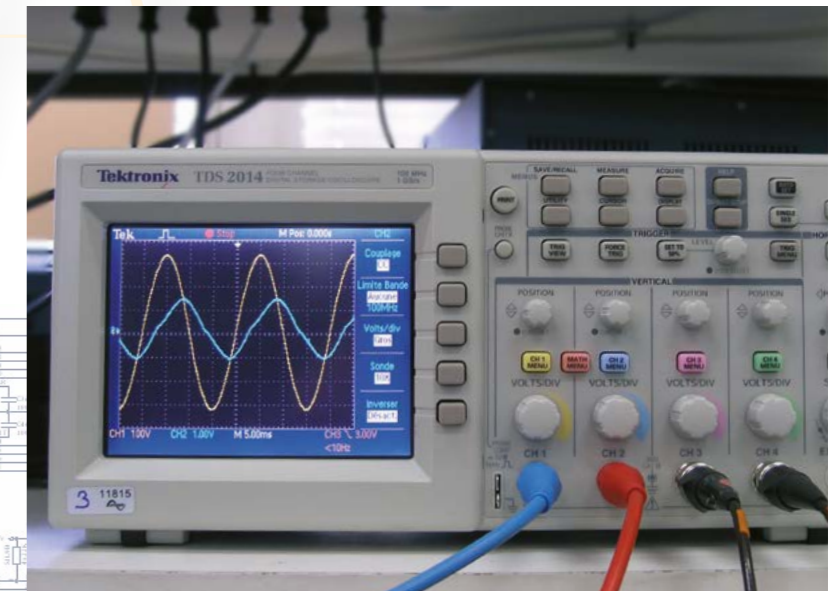



Security and comfort (lighting, heating, household appliances, leisure electronics, telecom...) can now be provided by autonomous energy systems; when far away from any electrical grid, either by choice or necessity.

These systems consist of three main components: first an energy source; normally a genset, a solar generator, a wind turbine or a combination of these; second battery storage; and third devices (inverter/charger, battery charger) able to charge the battery from the energy source(s) and to supply users with AC voltage (inverter, inverter/charger).

The examples below show the products in some stand-alone applications.



A complete solar system

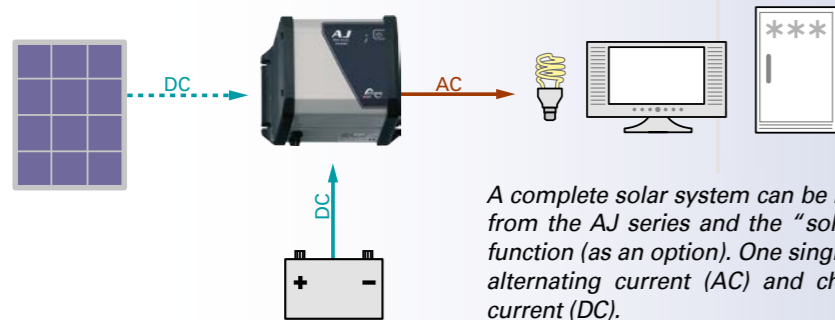

A complete solar system can be built by combining an inverter from the AJ series and the "solar charge control" integrated function (as an option). One single device can then both supply alternating current (AC) and charge the battery with direct current (DC).

Inverters
AJ Series p. 28
(275 - 2'400VA)

Quality AC voltage for all electrical appliances

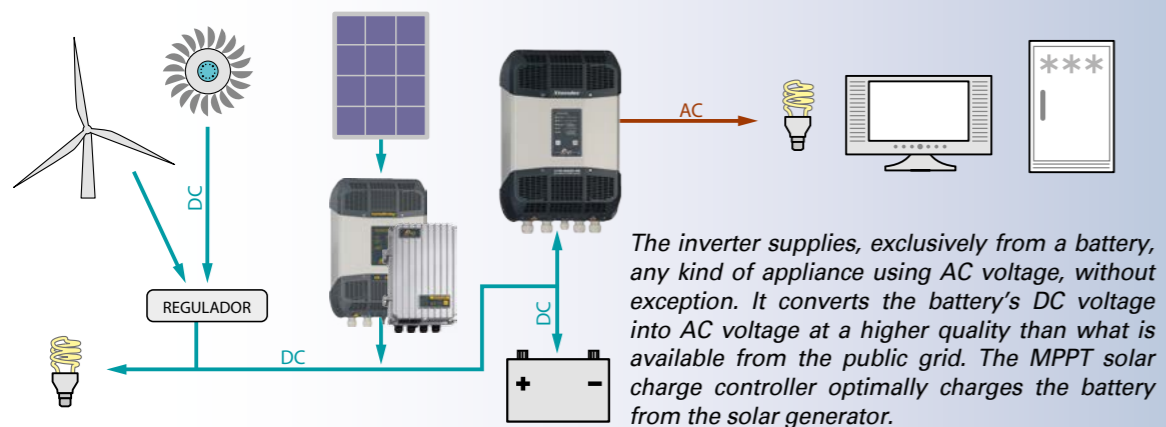

The inverter supplies, exclusively from a battery, any kind of appliance using AC voltage, without exception. It converts the battery's DC voltage into AC voltage at a higher quality than what is available from the public grid. The MPPT solar charge controller optimally charges the battery from the solar generator.

Inverters
Xtender Series p. 18
(900 - 72'000VA)
Compact Series p. 26
(1'400 - 4'000VA)
AJ Series p. 28
(275 - 2'400VA)
MPPT solar charge controllers
VarioTrack Series p. 14
(65 - 80A)
VarioString Series S. 16
(70 - 120A)



Village electrification

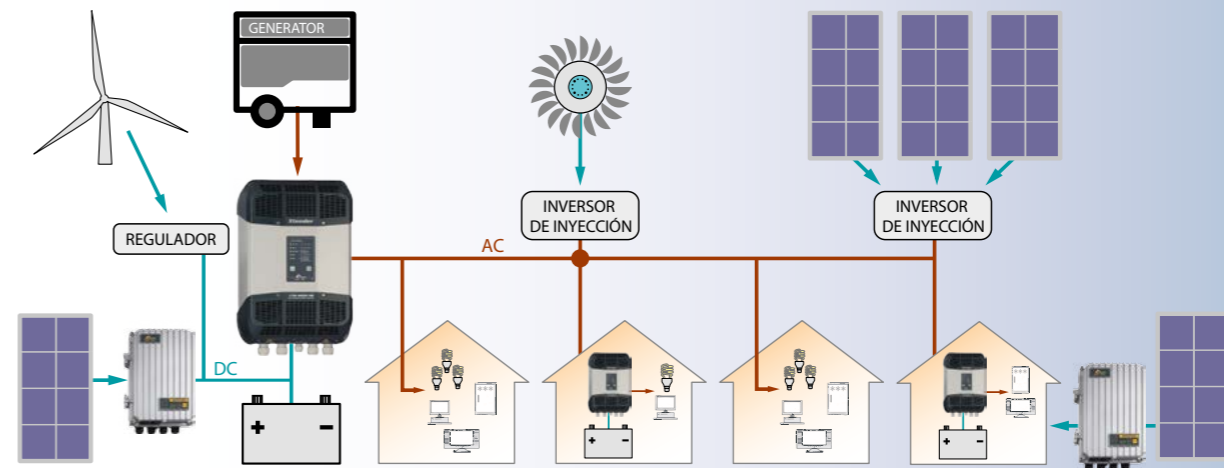

Various power sources supply energy to several consumer points.

Inverters
Xtender Series p. 18
(900 - 72'000VA)

Hybrid system: more autonomy and flexibility

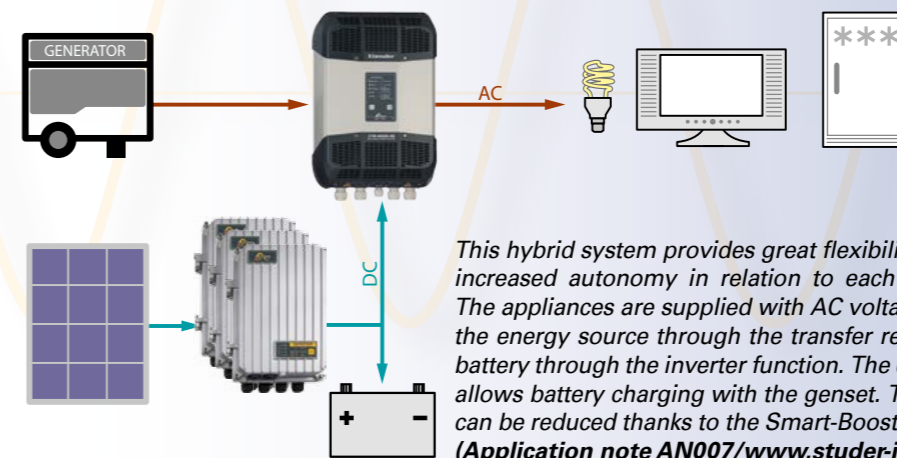

This hybrid system provides great flexibility in supply and increased autonomy in relation to each energy source. The appliances are supplied with AC voltage directly from the energy source through the transfer relay, or from the battery through the inverter function. The charger function allows battery charging with the genset. The genset's size can be reduced thanks to the Smart-Boost function. (Application note AN007/www.studer-innotec.com)

Inverters
Xtender Series p. 18
(900 - 72'000VA)
Compact Series p. 26
(1'400 - 4'000VA)

MPPT solar charge controllers
VarioTrack Series p. 14
(65 - 80A)
VarioString Series p. 16
(70 - 120A)

3-phase grid 3 x 400Vac for high power appliances

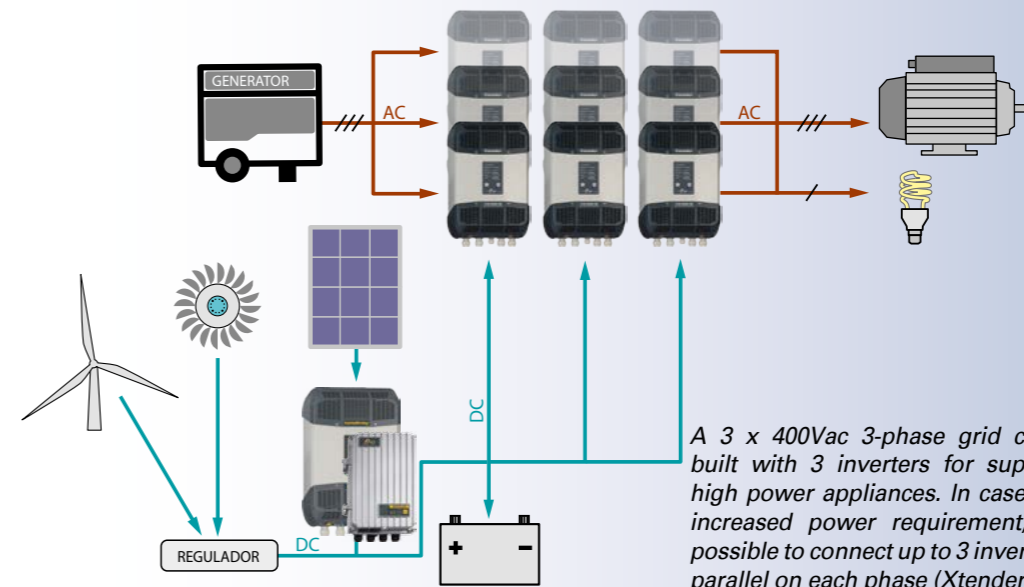

A 3 x 400Vac 3-phase grid can be built with 3 inverters for supplying high power appliances. In case of an increased power requirement, it is possible to connect up to 3 inverters in parallel on each phase (Xtender only).

Inverters
Xtender Series p. 18
(900 - 72'000VA)

MPPT solar charge controllers
VarioTrack Series p. 14
(65 - 80A)
VarioString Series p. 16
(70 - 120A)



A simple on-board energy system is often necessary to power the AC voltage appliances, while the vehicle or the boat is away from the electrical grid (port, garage, camping...).

In this case, energy is stored in the battery, which is actually charged by power sources on-board, such as a genset, solar generator, wind turbine, alternator or a combination of these. Studer Innotec offers a complete product range that ensures the management and conversion of this energy, while securing an optimal power supply to the on-board appliances.

The examples below show our products in some mobile applications.

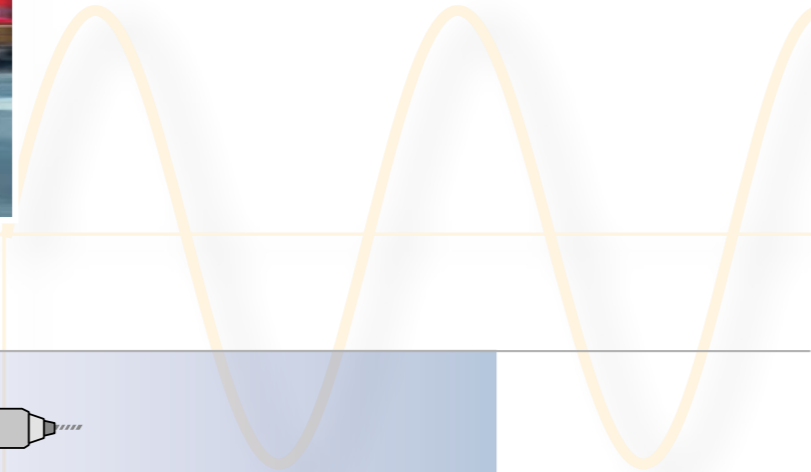

A simple and reliable on-board system

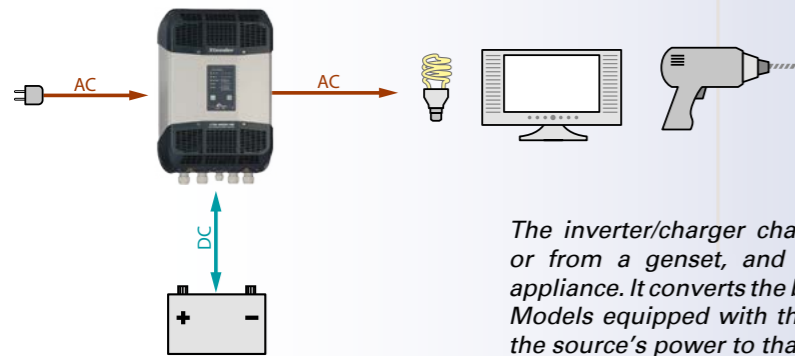

The inverter/charger charges the battery from the grid or from a genset, and powers any kind of electrical appliance. It converts the battery DC voltage to AC voltage. Models equipped with the Smart-Boost system can add the source's power to that of the inverter.

Inverters
Xtender Series p. 18 (900 - 72'000VA)
Compact Series p. 26 (1'400 - 4'000VA)

An upgradeable power

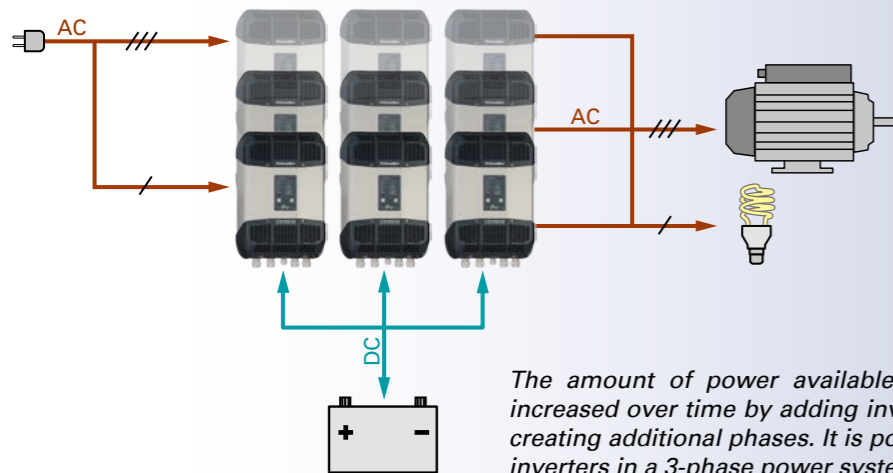

The amount of power available to the users can be increased over time by adding inverters in parallel or by creating additional phases. It is possible to install up to 9 inverters in a 3-phase power system.

Inverters
Xtender Series p. 18 (900 - 72'000VA)

3 x 400Vac 3-phase grid on-board

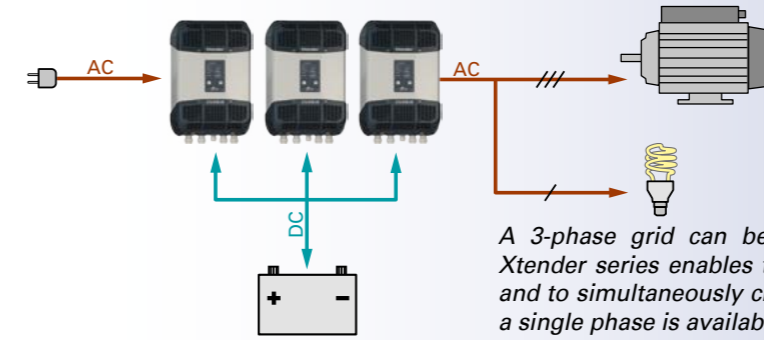

A 3-phase grid can be built with 3 inverters. The Xtender series enables the creation of a 3-phase grid and to simultaneously charge the battery, even if only a single phase is available as a power source.

Inverters
Xtender Series p. 18 (900 - 72'000VA)

Variable power source assistance

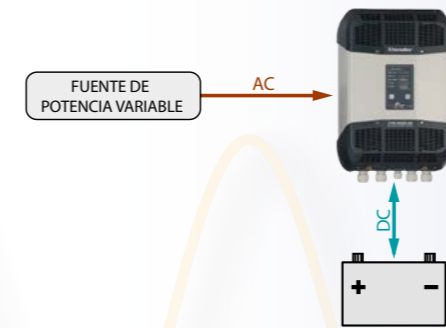

The source being a variable power alternator, the Smart-boost will supply the power difference in order that the power delivered is always the same (Application note AN004/www.studer-innotec.com).

Inverters
Xtender Series p. 18 (900 - 72'000VA)

Successive battery charging

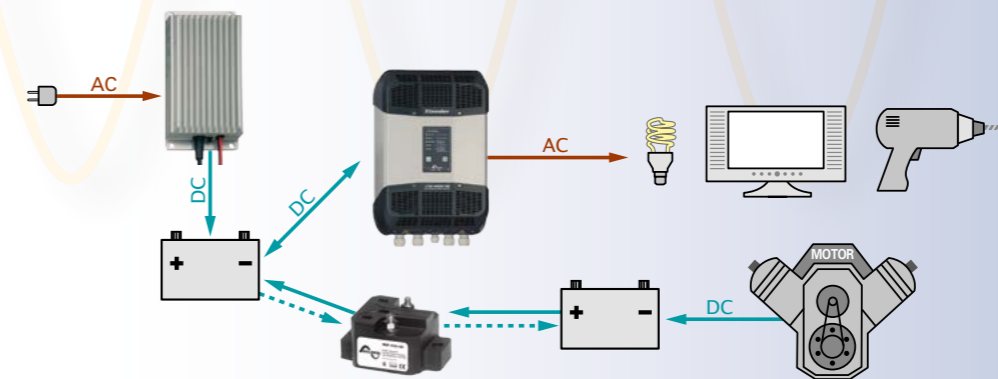

In this system, a battery separator enables one or several auxiliary batteries to be charged, once the primary battery is charged.

Battery separators
MBR Series p. 32

Battery chargers
MBC series p. 30

Simultaneous battery charging and DC/DC conversion

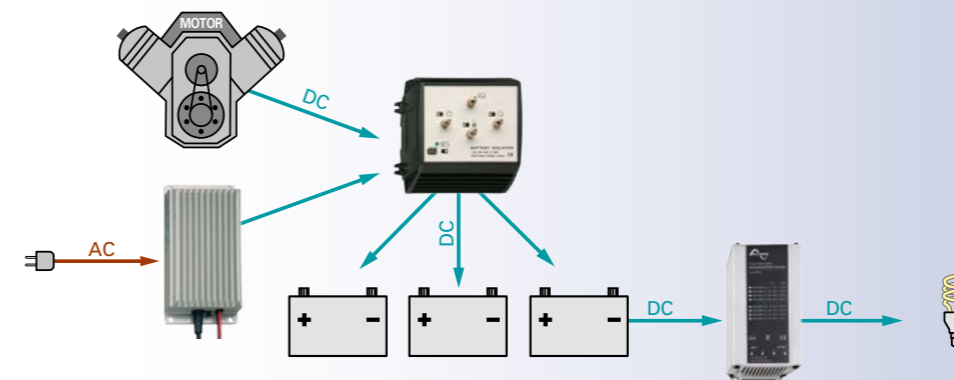

A MOSFET splitter, with almost no voltage losses, splits the charge current among several batteries. From the battery pack, a DC/DC converter will step up or down the voltage according to the voltage of the users: 12 or 24Vdc.

MOSFET battery splitters
MBI Series p. 32

Battery chargers
MBC Series p. 30

DC/DC converters
MDCI-MDC Series p. 31



Appliances such as fridges, PCs, emergency lights, etc. which are supplied by the public grid and cannot afford any power cut, are electrically secured.

An inverter/charger with transfer relay or a combination of an inverter and a charger guarantees that the battery is well maintained and that an uninterrupted power supply to strategic appliances is sustained.

Studer Innotec offers solutions from 275VA up to 72kVA with a one of a kind product choice that remains unchallenged on the market.

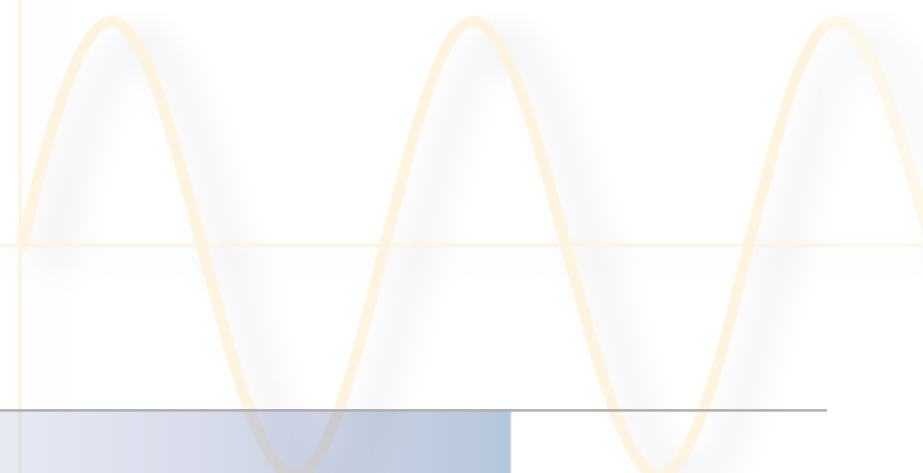

Uninterruptible power supply on-line

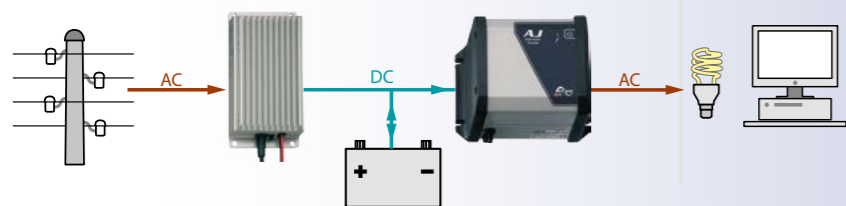

In this system, the battery charge functions and appliances' power supply are separated: On one side is a battery charger, and on the other, an inverter. Grid current fluctuations have no impact on the appliances.

Inverters
AJ Series p. 28
(275 - 2'400VA)

Battery chargers
MBC Series p. 30

Uninterruptible power supply off-line

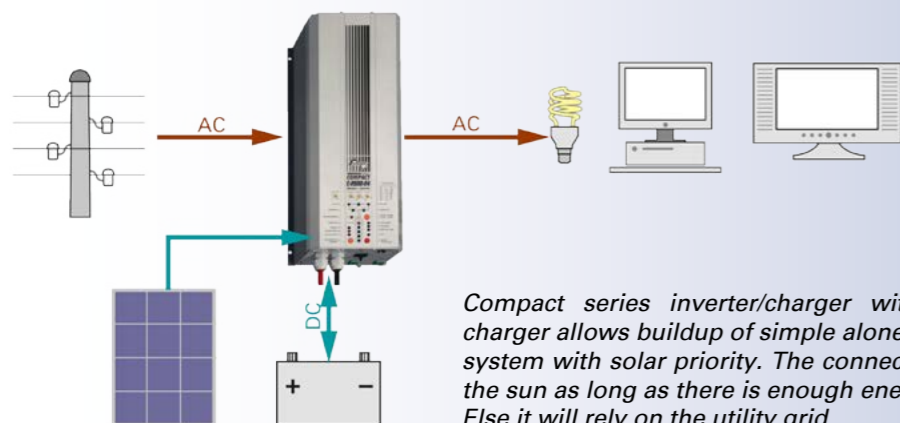

Compact series inverter/charger with built in solar charger allows buildup of simple alone one solar backup system with solar priority. The connected loads runs on the sun as long as there is enough energy in the system. Else it will rely on the utility grid.

Inverters
Compact Series p. 26
(1'400 - 4'000VA)

UPS with solar backup and solar priority

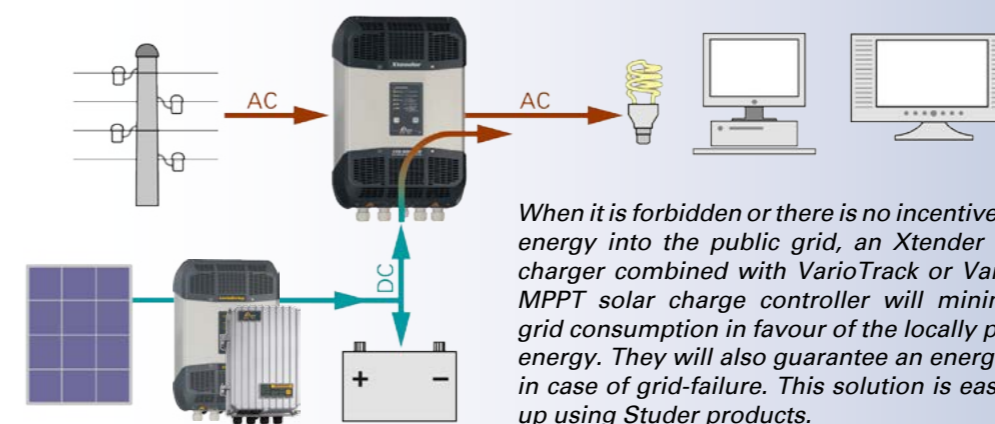

When it is forbidden or there is no incentive to inject energy into the public grid, an Xtender inverter-charger combined with VarioTrack or VarioString MPPT solar charge controller will minimize the grid consumption in favour of the locally produced energy. They will also guarantee an energy supply in case of grid-failure. This solution is easy to set-up using Studer products.

Inverters
Xtender Series p. 18
(900 - 72'000VA)
Compact Series p. 26
(1'400 - 4'000VA)

MPPT solar charge controllers
VarioTrack Series p. 14
(65-80A)
VarioString Series p. 16
(70 - 120A)

Individual Home backup

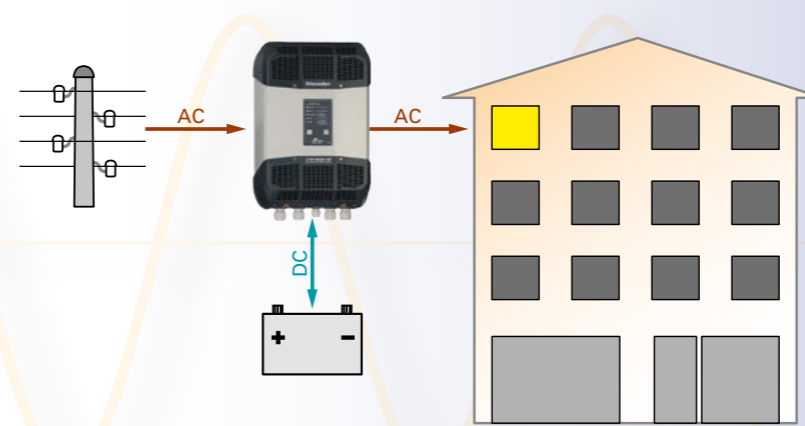

An inverter/charger is used to provide backup power in case of public grid outage. As soon as the power shuts down the inverter/charger switches to inverter mode and assures an uninterruptible power supply.

Inverters
Xtender Series p. 18
(900 - 72'000VA)
Compact Series p. 26
(1'400 - 4'000VA)

Solsafe – a backup system for grid connected solar installations

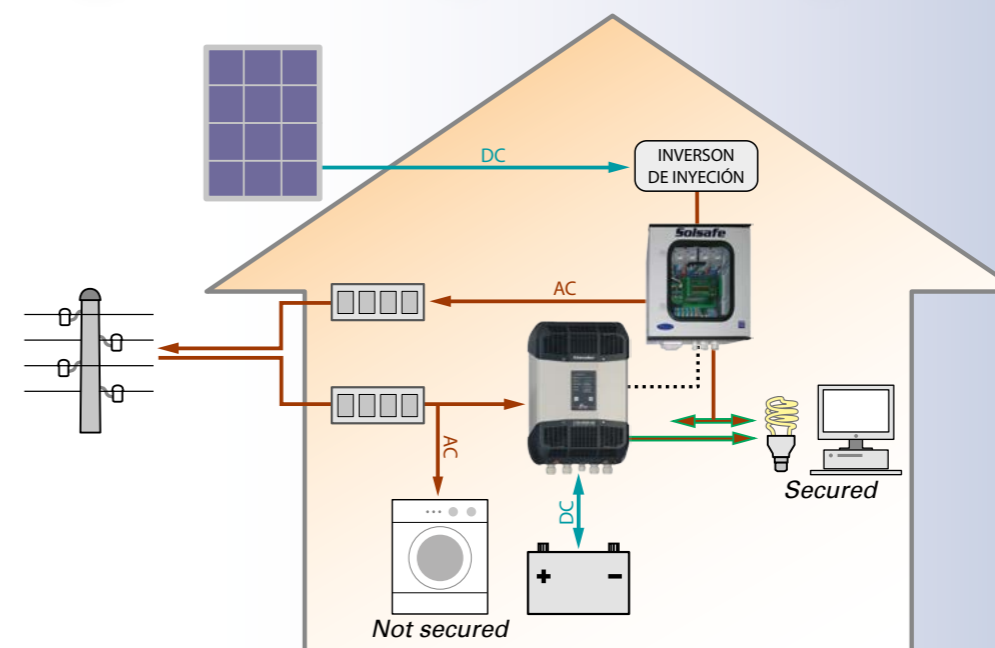

The installation of our Solsafe solution in a grid connected solar system provides the option to secure the power supply in case of a power cut to all loads or only priority loads, and thus maintains the ongoing use of solar energy being produced. (Application note AN003/www.studer-innotec.com).

Inverters
Xtender Series p. 18
(900 - 72'000VA)
Compact Series p. 26
(1'4000 - 4'000VA)



In order to give priority to consumption of the energy generated from your own solar or renewable installation, different systems including the Xtender inverter-chargers can be set up.

These systems store excess energy produced during daytime in batteries to be used at a later time, maximizing self-consumption. The public grid will only be used to import or export small amounts of energy if absolutely necessary.

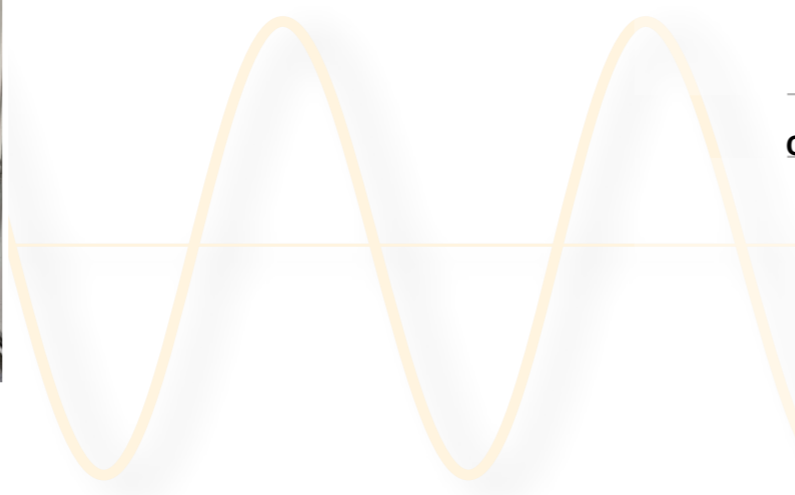

Simple solar priority system

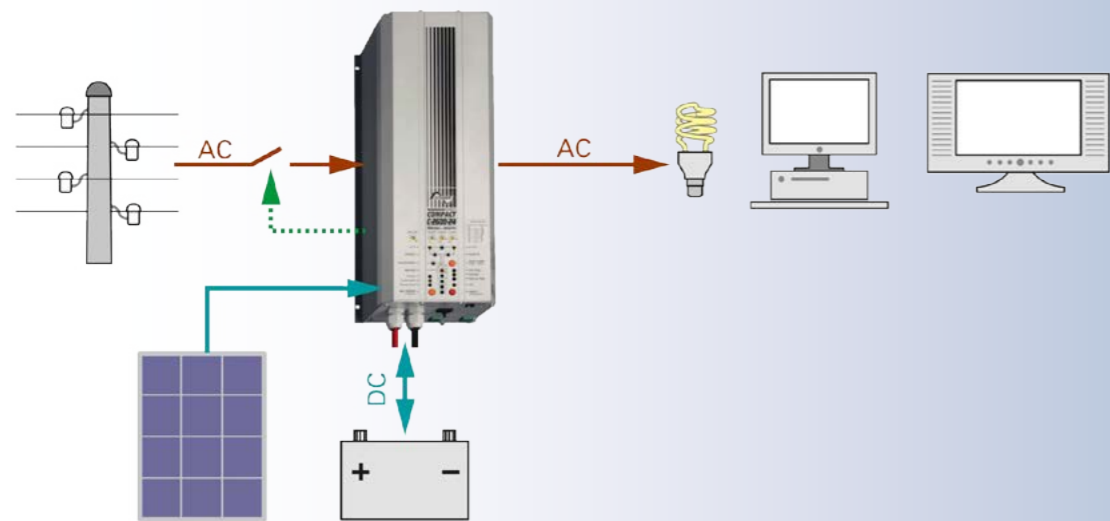

Compact series inverter/charger with built-in (or external) solar charger allows to buildup a simple solar backup system with solar priority. The connected loads run on the sun as long as there is enough energy in the system. When the battery is below a certain level, it will rely on the utility grid.

Inverters
Compact Series p. 26
(1'400 - 4'000VA)

Priority to renewable energy without grid-injection

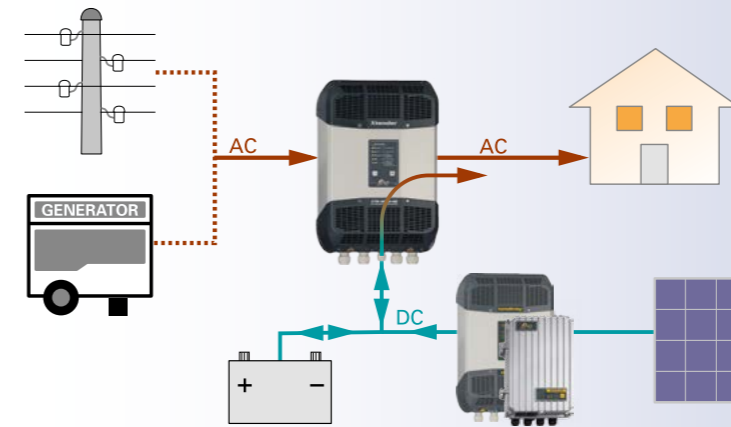

When it is forbidden or there is no incentive to inject energy into the public grid, an Xtender inverter-charger combined with VarioTrack or VarioString MPPT solar charge controller will minimize the grid consumption in favour of the locally produced energy. They will also guarantee an energy supply in case of grid-failure. This solution is easy to set-up using Studer products.

Inverters
Xtender Series p. 18
(900 - 72'000VA)

MPPT solar charge controllers
VarioTrack Series p. 14
(65-80A)
VarioString Series p. 16
(70 - 120A)

Optimising self-consumption with partial backup

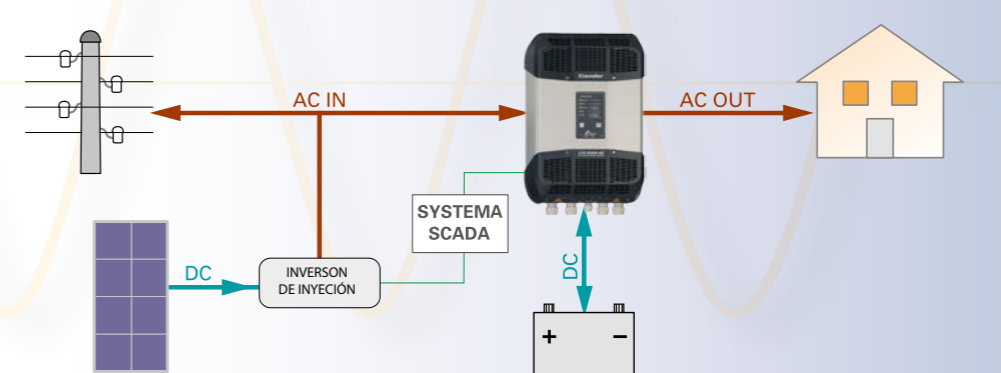

This system has the advantage of being easily integrated into an existing grid-feeding installation even when its power is higher than that of the Xtender. The self-consumption is optimized by means of an expert control system (SCADA) supplied by partners of Studer Innotech. This system also allows creating a separate secure grid adapted for selected backup appliances (e.g. lights, cooling systems and communication).

Inverters
Xtender Series p. 18
(900 - 72'000VA)

Optimising self-consumption with full backup

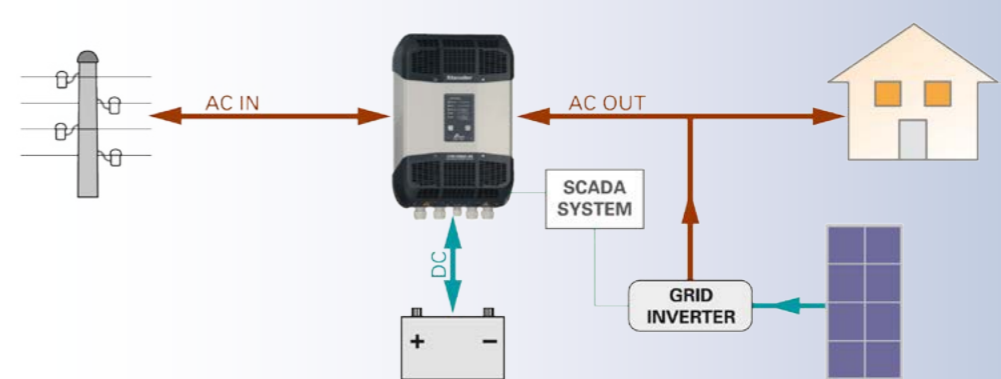

This system will secure all user (household) appliances however it requires that the power of the Xtender is at least equivalent to the grid inverter and that it covers the household's power needs. The self-consumption is optimized by means of an expert control system (SCADA) supplied by partners of Studer Innotech. A correctly sized system adapted to meet the customer's needs guarantees the energy supply during power outages of the public grid.

Inverters
Xtender Series p. 18
(3500 - 72'000VA)



VarioTrack Series

The VarioTrack solar charge controller maximizes the energy generated from solar panels in any solar installation. It contains an MPPT (Maximum Power Point Tracking) algorithm that continuously tracks the maximum power point and automatically charges the batteries in an optimal way with all the available solar power.



VarioTrack
VT-65



VarioTrack
VT-80

Main features

- Easy and safe commissioning with full protection against incorrect wiring
- Rugged and durable, this device is designed to perform in harsh environmental conditions (IP54)
- High conversion efficiency >99%
- Up to 15 VarioTrack in parallel on the same communication bus
- 4 step charger for longer battery life
- Low self-consumption: <1W in night time mode
- Display with 7 LEDs showing status and current
- Comprehensive display, programming and datalogging with RCC-02/-03
- Communication sets with Xcom-LAN, Xcom-GSM, Xcom-SMS (opt.)
- Suitable for any solar system
- Optimal usage in an Xtender system with synchronized battery management



VarioTrack Series	Nominal battery voltage	Maximum power of the solar generator	Maximum voltage of the solar generator	Maximum charging current to the battery
VT-65	12 V	1000 W	80 Vdc	65A
	24 V	2000 W	150 Vdc	
	48 V	4000 W	150 Vdc	
VT-80	12 V	1250 W	80 Vdc	80A
	24 V	2500 W	150 Vdc	
	48 V	5000 W	150 Vdc	

* Complete technical specifications on page 34

The VarioTrack in an Xtender system

Designed to function in any solar installation, the VarioTrack works optimally in an Xtender system. The communication between the two devices allows for synchronized battery management.

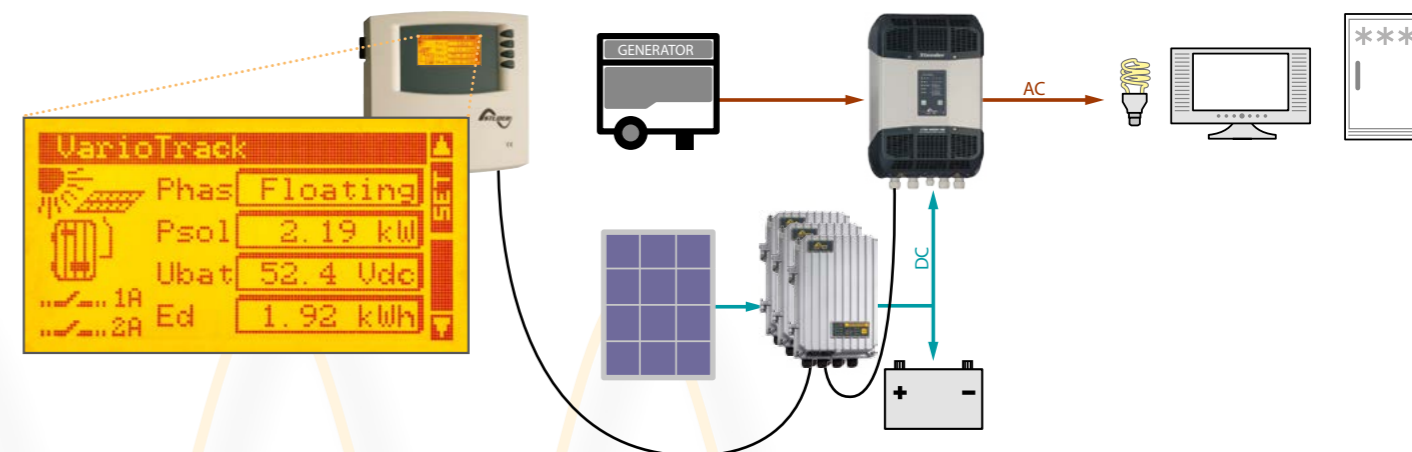

Display and programming possibilities

The VarioTrack is fitted with several indicator lights and a control button for its basic operation. It is also possible to do basic programming using the DIP switches situated inside the device. By adding a remote control and programming center RCC-02/-03, the VarioTrack can use all functions available in the remote control such as display, programming, data logging etc.





VarioString Series

The VarioString family is comprised of 2 models of MPPT solar charge controllers with 70A or 120A battery charge current for 48V batteries. The devices have one (VS-70) or two (VS-120) MPPT inputs to connect PV modules and, due to the use of transformers, have full isolation between the PV and battery circuits. When connected independently or in parallel, the MPPT inputs allow for a PV voltage range of 200 to 600V. The VS-120, with its MPPT inputs connected in series, provides the option of a PV voltage from 400 to 900V.

Main features

- Reduces Balance of System costs (eliminates expensive wiring for parallel strings, saving wires, connectors, junction boxes, fuses, space, time, etc.)
- Safe, simple and trouble free connection with SUNCLIX™ (Phoenix Contact "tool free") PjV connector
- Safety, guaranteed, thanks to the reinforced isolation between the PV generator and battery and between the two PV inputs of the VS-120. This allows for independent earthing of the battery and/or solar modules*.
- World champion for efficiency in isolated converter with >98 % conversion efficiency
- 7kW per unit and up to 15 units in parallel: 105kW
- 4 step charger fully programmable for longer battery life
- 9 LEDs to monitor status and current
- Full display, configuration and data acquisition with RCC-02/03 and/or via the internet with the Xcom LAN/Xcom-GSM or via SMS with Xcom-SMS (see p. 23-24).

* Many manufacturers recommend that one of the poles of the solar generator be earthed to avoid PID (Potential Induced Degradation). It has been shown that this degradation can rapidly reach up to 60% of the initial power.

VarioString VS-120



VarioString VS-70



VarioString Series

	VS-70	VS-120		
	MPPT	MPPT 1 or 2	1 + 2 in parallel	1 + 2 in serie
Maximum Solar Power recommended	4000 W	3500 W	7000 W	7000 W
Maximum PV Current	13 A	13 A	26 A	13 A
Maximum open circuit voltage	600 V	600 V	600 V	900 V
Minimum functional circuit voltage	200 V	200 V	200 V	400 V
Recommended MPPT voltage	250-500 V	250-500 V	250-500 V	500-750 V
Maximum output current	70 A	60 A	120 A	120 A
Battery voltage	48 V nom. (38-68 V)			

* Complete technical specifications on page 35

VS-70 and VS-120: Flexibles & complementary

Both VarioString models complement each other so that they are able to meet the diverse requirements of a given system. For example, the choice of an IP54 casing for the VS-70 or the elevated power of the VS-120.

They are also configurable via DIP Switch.

The MPPT inputs are equipped with SUNCLIX™ connectors and, with the VS-120, can be connected separately, in parallel or in series for maximum flexibility in PV array design.

Integrated in an IP54 casing, the features of the VS-70 are similar to the VS-120: both can control 2 auxiliary relays (with ARM-02 accessory) that allow, for example, to control the start-up of a generator or the disconnection of non-priority loads.

Display and programming possibilities

The VarioString devices are equipped with a control button and indicator lights for a clear reading of the state of the device and the battery charge current.

The setting of the battery charge cycle suitable for different battery types is possible using DIP switches within the device. Equipped with Studer CAN bus connections, the VarioString devices are compatible with Xtender family communication, display, and data acquisition accessories (RCC and Xcom see p. 23-24), which allow for custom programming of the system. The VS-70 (and soon the VS-120) has a remote entry which allows it to control the start/stop of the MPPT charge controller or program another function with the RCC-02/03 (such as to force an equalization).

The VarioString in an Xtender system

Designed to work in any solar installation, the VarioString series works best in an Xtender system.

Communication between the devices allows for synchronized battery management and full use of Xtender accessories.

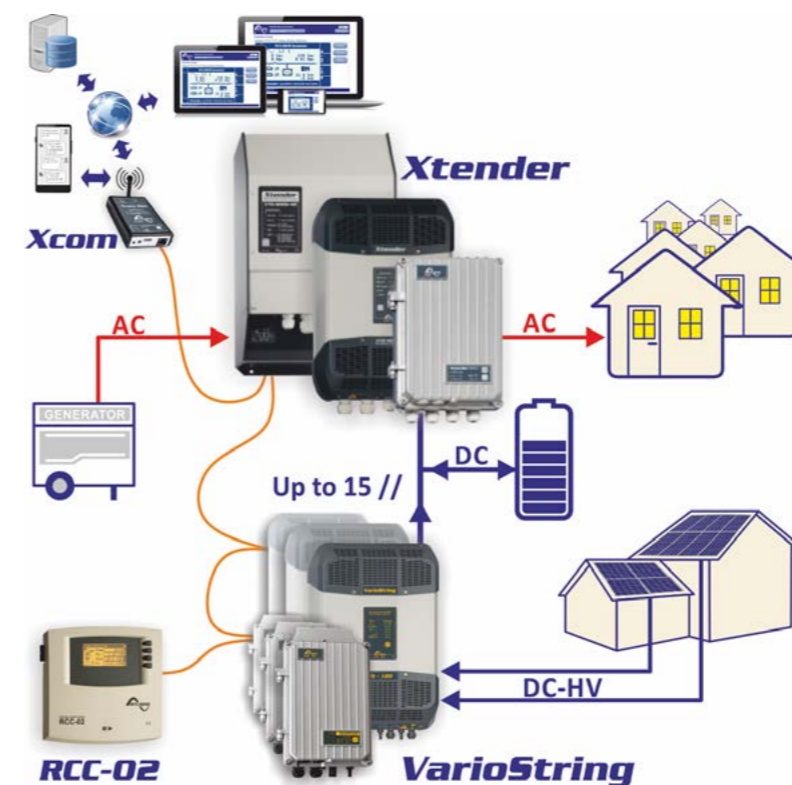
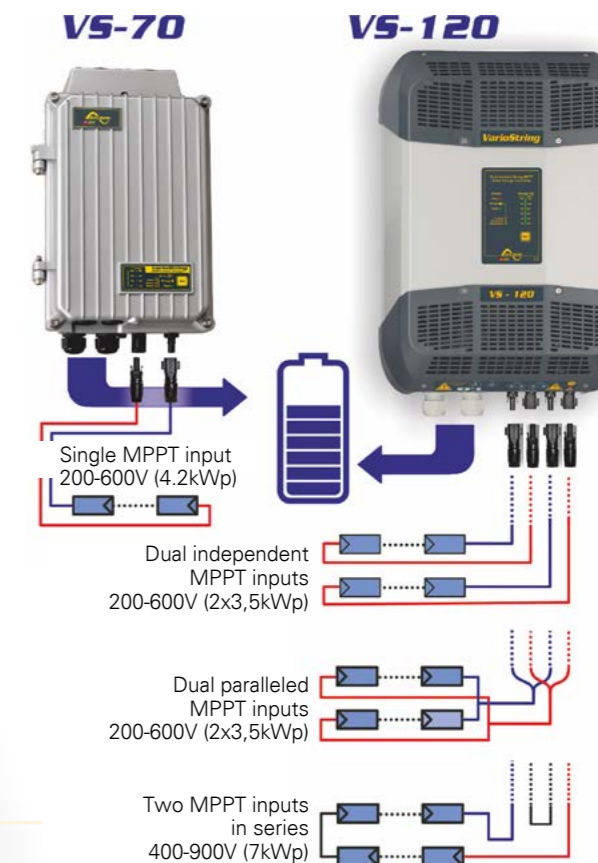



Xtender Series

The Xtender series provides unmatched freedom of use due to its many functions. In a basic application, it offers a total package: the functions of inverter, battery charger, transfer system and assistance to the source. These functions can be combined and controlled in a totally automatic way for exceptional ease and optimal management of available energy.

The Xtender is equipped with a command entry and 2 configurable auxiliary contacts. This allows automatic control of a genset or loadshedding when the battery voltage is too low. The flexibility obtained makes it possible to implement special functionalities, often necessary for good energy management in standalone systems.

Xtender XTS

XTS 900-12
XTS 1200-24
XTS 1400-48



Xtender XTM

XTM 1500-12
XTM 2000-12
XTM 2400-24
XTM 2600-48
XTM 3500-24
XTM 4000-48



Xtender XTH

XTH 3000-12
XTH 5000-24
XTH 6000-48
XTH 8000-48



Main features

- Outstanding efficiency and overload
- Perfect management and limitation of AC sources
- Power shaving of the consumption peaks
- Automatic allocation of available power
- Active filtering of load steps on the genset
- Automatic protection of the sources against overload
- Battery priority (or to renewable sources)
- Parallel and three-phase setting, up to 9 units (72kVA)
- Powerful multi-stage PFC charger
- Ultra-short transfer time (from 0 to 15ms max.)
- Automatic and efficient stand-by
- 2 programmable auxiliary contacts (optional on the XTS)
- Compatible with AC coupling
- XTS electronically protected against reverse polarity
- Display, programming and data logging integrated in the remote control (RCC)
- Interactive with the Battery Status Processor (BSP)
- RS-232 communication for remote supervision

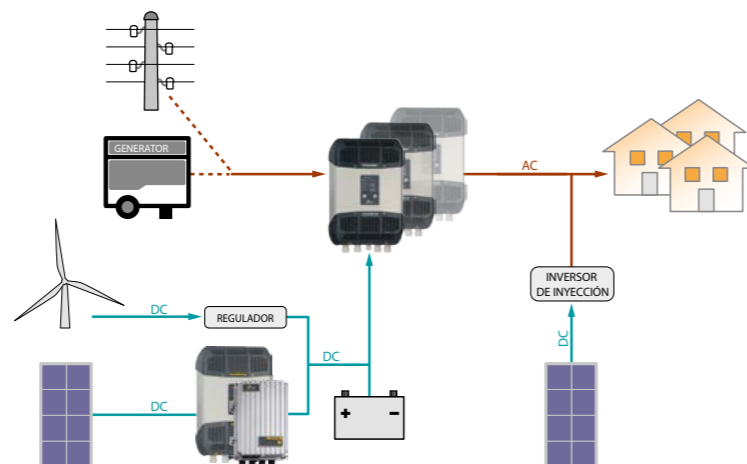

Xtender Series

	Output power P30/Pnom	Power Smart-Boost	Battery voltage	AC voltage	Charge current	Transfer current
XTS 900-12	900 VA** / 500 VA	900 VA**	12 V	230 Vac*	0 - 35 A	16 A
XTS 1200-24	1200 VA** / 650 VA	1200 VA**	24 V	230 Vac*	0 - 25 A	16 A
XTS 1400-48	1400 VA** / 750 VA	1400 VA**	48 V	230 Vac*	0 - 12 A	16 A
XTM 1500-12	1500 VA / 1500 VA	1500 VA	12 V	230 Vac*	0 - 70 A	50 A
XTM 2000-12	2000 VA / 2000 VA	2000 VA	12 V	230 Vac*	0 - 100 A	50 A
XTM 2400-24	2400 VA / 2000 VA	2400 VA	24 V	230 Vac*	0 - 55 A	50 A
XTM 2600-48	2600 VA / 2000 VA	2600 VA	48 V	230 Vac*	0 - 30 A	50 A
XTM 3500-24	3500 VA / 3000 VA	3500 VA	24 V	230 Vac*	0 - 90 A	50 A
XTM 4000-48	4000 VA / 3500 VA	4000 VA	48 V	230 Vac*	0 - 50 A	50 A
XTH 3000-12	3000 VA / 2500 VA	3000 VA	12 V	230 Vac*	0 - 160 A	50 A
XTH 5000-24	5000 VA / 4500 VA	5000 VA	24 V	230 Vac*	0 - 140 A	50 A
XTH 6000-48	6000 VA / 5000 VA	6000 VA	48 V	230 Vac*	0 - 100 A	50 A
XTH 8000-48	8000 VA / 7000 VA	8000 VA	48 V	230 Vac	0 - 120 A	50 A

* For the 120Vac/60Hz version, -01 is added to the model designation
** These features are valid only when using the cooling module ECF-01
Complete technical specifications on page 36

Smart-Boost function and active filtering

With this function it is possible to interact directly with the AC source (Genset or grid) and to implement some basic functions such as:

- Efficient and immediate limitation of the current of the source, including none linear or inductive/ capacitive loads, protecting efficiently the breakers during connection to shore power or to a camping power meter with limited current (function of power shaving and power assistance) **(more information on our website and in the Application note AN001/www.studer-innotec.com)**.
- Power shaving of load steps on the generator allowing an optimal sizing of the generator and assuring the best possible efficiency of the fossil fuels (function of filtering and of power assistance).

The function of assistance to the source enables also to implement advanced functions such as the priority use of renewable energy, even when the grid is available **(more information on our website and in the Application note AN002/www.studer-innotec.com)**.

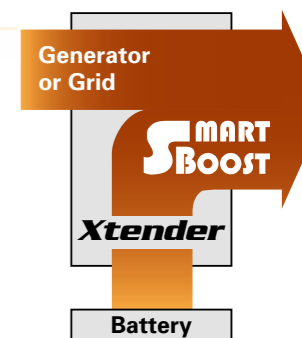

The new alpine cabin of Monte-Rosa with an Xtender system

The main configurations offered by the Xtender Series

Wide modularity

By the implementation of several units, it is possible to create a 3-phase source or to set them in parallel to increase the power available without extra cost. Up to 9 inverters of the Xtender Series can be combined together for up to 72kVA!



Easy set up of multi-units



Compatible with standard cable channel (230 x 60mm)

Self-consumption system for industrial building



Inverter, charger and transfer relay

The Xtender works as an inverter and as a charger, combined with a transfer relay.

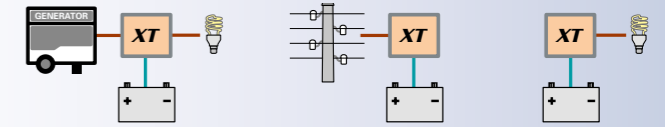

2 or 3 units in parallel on 1 phase

Increase the power on one phase by connecting 2 or 3 Xtender in parallel.

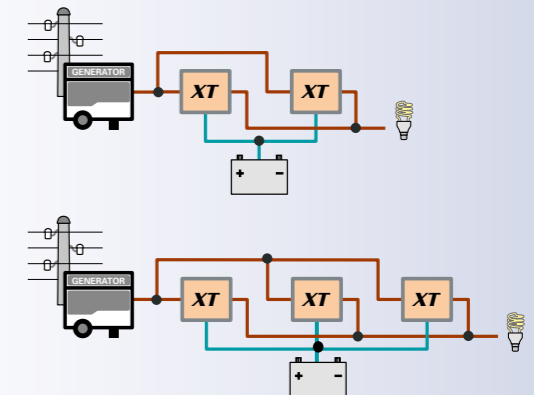

1 phase in and 3 phase out

Three-phase power supply from a single phase source.

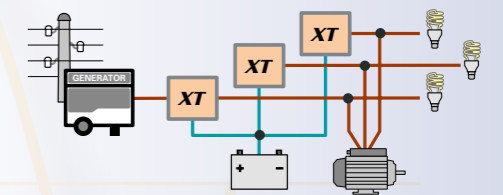

3 phase in and 3 phase out

Three-phase source for a three-phase power supply.

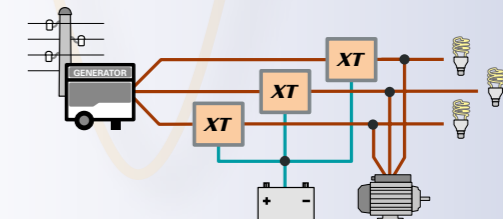

3 phase + with one reinforced phase

Three-phase power supply with increase of the power on one phase by connecting 2 or 3 Xtender in parallel on this phase.

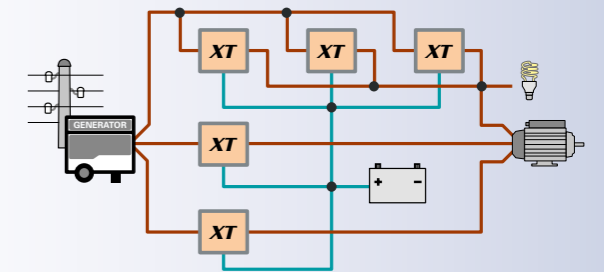

3 Xtender in parallel on 3 phases

Three-phase power supply with 3 Xtender on each phase, for power up to 72kVA.

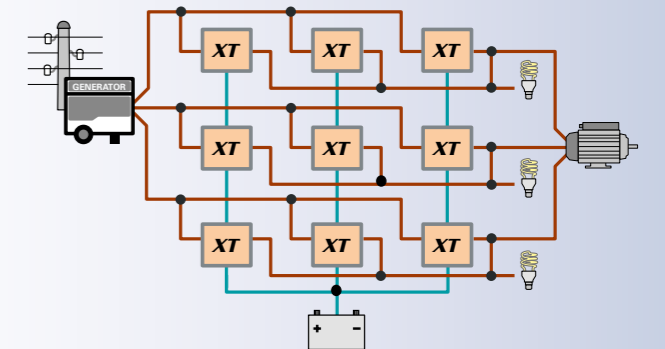



X-Connect system

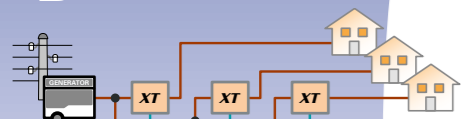

Centralized

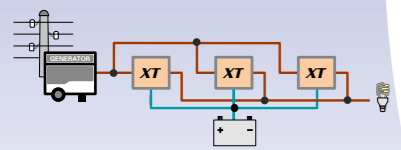

Parallel

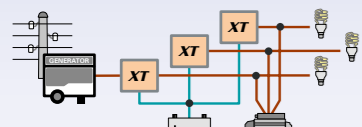

3-phase

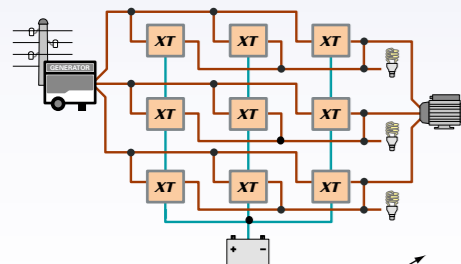

Parallel + 3-phase

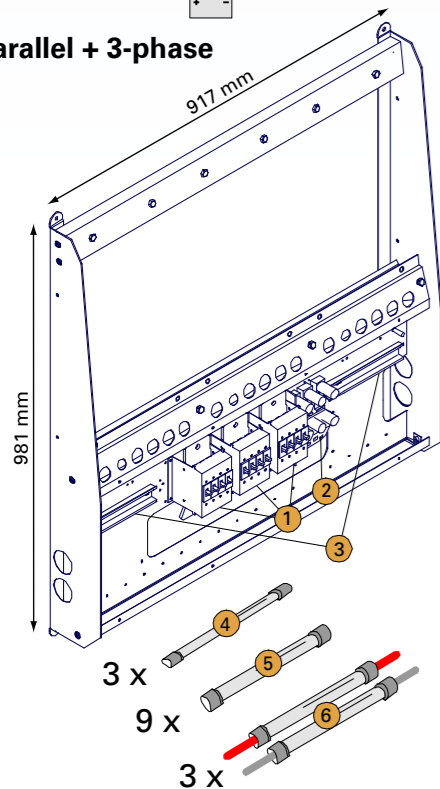

Mounting frame for Xtender multi-system

Offers a flexible and cost effective solution for high power systems based on the XTH inverter.

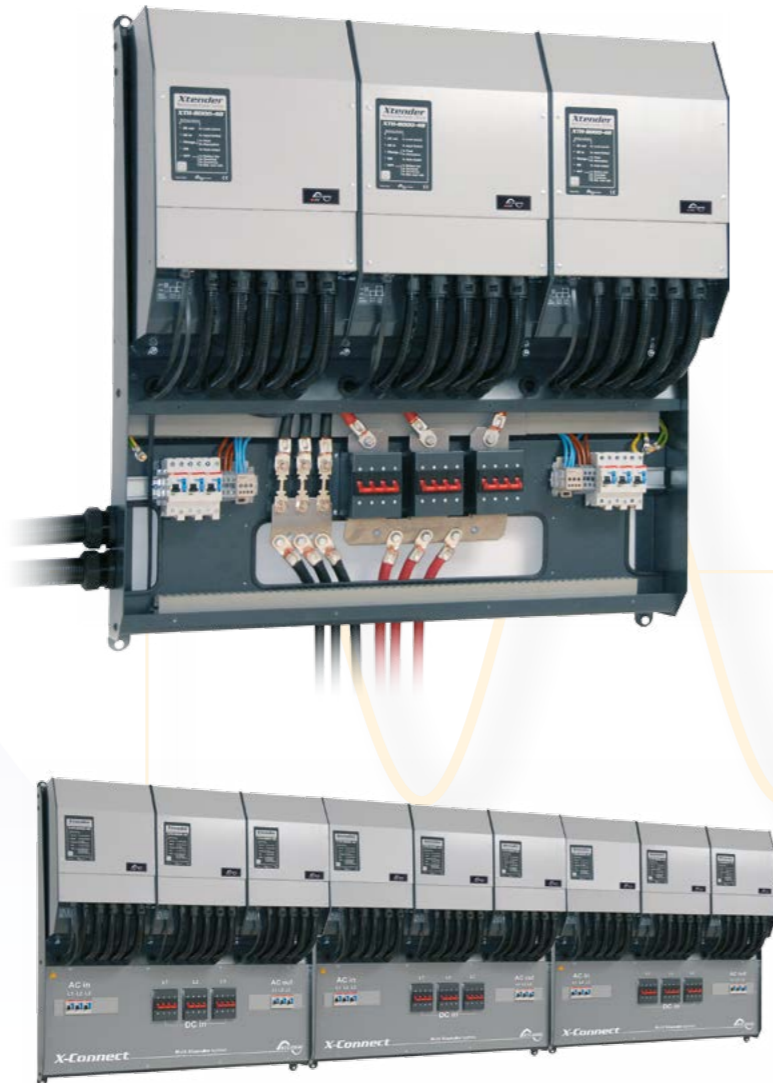

Up to 72kVA multi-unit system

Frame is supplied with:

- 1 Pre-installed DC circuit breakers
- 2 Pre-installed DC fuses
- 3 Pre-installed DIN rails
- 4 Interconnection pipes and gland for auxiliary contact wiring
- 5 Interconnection pipes and gland for AC wiring
- 6 Interconnection pipes and gland + 90mm² wire terminated with appropriate ring tongues for DC wiring from Xtender to breakers and fuses

Screws set for frame assembly

Xtender/VarioTrack/VarioString Accessories



Remote control and programming centre RCC-02 or RCC-03

Apart from the enclosure difference, adapted for wall or panel mounting, both units have exactly the same features and allow the user to survey his system and fully customize it to his needs. The RCC gives a controlled access to the many adjustable parameters of the Xtender and the VarioTrack/VarioString. It enables the setting of the charge curve of the battery, the programming of the auxiliary contacts and gives access to a lot of operation options. Thanks to its graphic display the RCC provides clear and comprehensive indications on the state of the system in a selectable language. The unit records and displays the events that occurred on an installation and so it anticipates the problems that might appear. A slot for an SD card is incorporated in the RCC which allows parameters and log data to be recorded as well as a software update of the entire system.

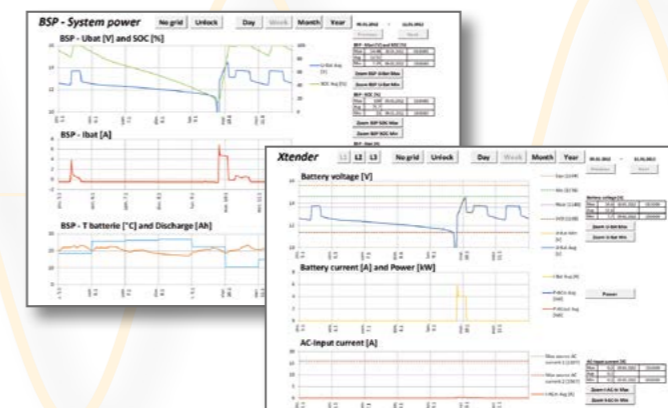

Data logging and analysis

Analyse easily your data with the RCC-02/03 Data logger function that will record on the SD card the main electrical values of your Xtender system during its operation.

These standards enable the analysis of the system's energy consumption evolution, to check the power cuts, the state of the auxiliary contacts, the input currents and voltages, etc.

Studer Innotec offers for free a graphical and analysis tools, Xtender Data Analysis Tool. **(more information on our website and in the Application note AN006/www.studer-innotec.com).**

Battery Status Processor BSP for Xtender and VarioTrack/VarioString systems

One of the most important values for safe and effective operating of an energy system with batteries is their state of charge.

The BSP offers, for Xtender and VarioTrack/VarioString systems, a highly precise measuring and an extremely efficient algorithm that calculates the state of charge in the most accurate way.

The remote control RCC-02/03 provides data logging, the display of values and the graphical display of the state of charge history and the settings. Values of the BSP can be used in the programming of Xtender and VarioTrack/VarioString systems. In addition, 17 different values can be displayed such as:

- State of charge
- Voltage (12-24-48Vdc)
- Current
- Time to go
- Throughput energy
- Battery temperature

The two models, BSP 500 and BSP 1200, are supplied with a 500A or 1200A shunt respectively, a 5m cable for battery connection, and a 5m communication cable.

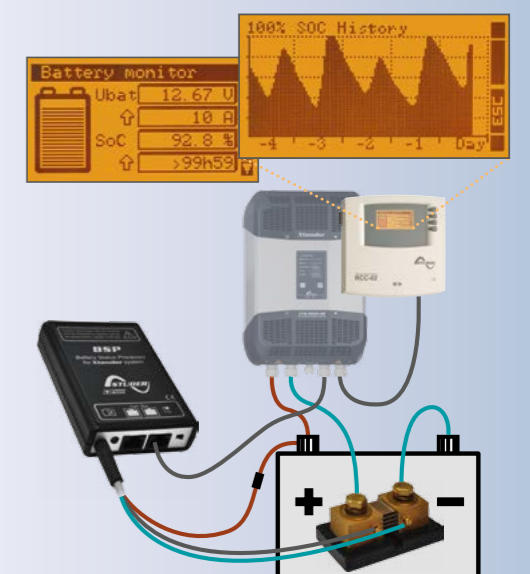

Communication for Xtender/ VarioTrack/VarioString

Communication sets by SMS or internet

The Xtender/Vario systems can be entirely and remotely controlled by mobile phone with the Xcom-SMS that requires a basic GSM (2G) coverage. The information exchange – change of parameters, data request, alarms or report sending, etc. – is then done by sending a simple SMS, secured by password

In addition, total control of the system is also possible via internet on our secured server. The connection with the internet is carried out either by the **Xcom-LAN**, provided the site has internet access via a local network; or by **Xcom-GSM**, if there the site has access to the mobile phone network with data (3G) coverage.

Our server will provide secure and full access – parameters, real time data, data log, configuration of alarms by SMS or E-Mail, etc. – to all sites with an **Xcom-LAN** or **Xcom-GSM** installed, and by means of any device with an internet browser: smartphone, PC or tablet.



Xtenders in the heart of the Spitzbergen...



Xtender/VarioTrack/VarioString Accessories

		XTS	XTM	XTH	VT	VS
	RCC-02/-03 The remote control module (with 2m cable) enables the setting of the parameters as well as the display of the values measured. By means of an SD card it is possible to log the system data and to save and restore the parameters of the system. This module is available either for wall mounting (model RCC-02), or for panel mounting (model RCC-03).	•	•	•	•	•
	BTS-01 Battery temperature sensor (with 5m cable) offering the automatic compensation of the adjustable thresholds of the battery voltage.	•	•	•	•	•
	RCM-10 Module for rail DIN mounting (with 5m cable) giving access to the main ON/OFF and to the command entry with the models XTS and XTM.	•	•			
	BSP 500/1200 Module meant for the measuring and calculating of the battery state of charge (with 5m cable). This module is connected to the communication bus of the Xtender. It allows the display and the datalogging of the values measured and calculated (see opposite screens) and also the control of the 2 auxiliary contacts of the Xtender.	•	•	•	•	•
	Xcom-232i Communication module with RS-232 port and 2m RJ45 cable, allowing access to the parameters and measured values of the Xtender system. It makes the link between an Xtender system and a SCADA supervision or control system (not supplied).	•	•	•	•	•
	Xcom-GSM Internet based communication sets The Xcom-GSM set includes one Xcom-232i, one cellular modem and all necessary accessories. The SIM card is not provided.	•	•	•	•	•
	Xcom-LAN Internet based communication sets The Xcom-LAN set includes one Xcom-232i, one Ethernet bridge and all necessary accessories.	•	•	•	•	•
	Xcom-SMS Communication set via SMS The Xcom-SMS set includes an Xcom-SMS, an antenna, and a micro SD card with SD card adapter.	•	•	•	•	•
	ARM-02 This module, only meant for the XTS and for the VT/VS models and for rail DIN mounting, is equipped with 2 auxiliary contacts controlled by the XTS or by the VT/VS. This function is already integrated in the models XTM and XTH.	•			•	•
	ECF-01 External cooling module (IP54) for XTS and VarioTrack (VT-65 only). The use of this accessory will increase the power of the XTS and the current of the VT65 to 80 A. The ECF-01 is directly installed on top of the casing and its mounting can be done at any time after installation.	•			•	
	X-Connect Mounting frame for multi-XTH system, supplied as a kit. The frame is equipped with DC breakers and fuses, and with rail DIN for the mounting of protection devices upstream and downstream (see p. 22).			•		
	CAB-RJ45-8-xx Communication cable for the connection between Xtenders and to all external accessories. The cables are available in the following lengths: 2, 5, 10, 20 or 50m (xx stands for the length). For instance: one system with 3 Xtenders requires 2 cables of 2m. One cable is supplied with every accessory. However a longer cable can be ordered when necessary.	•	•	•	•	•



Compact Series

The Compact series models consist of 3 fully automatic functions: a sine wave inverter, a battery charger and a transfer system. Equipped with high-end technology, they optimally perform, thanks to Studer Innotec's extensive experience in the field of electrical supply.



XP COMPACT

XPC 1400-12
XPC 2200-24
XPC 2200-48



COMPACT

C 1600-12
C 2600-24
C 4000-48

Main features

- True sine wave voltage
- Suitable for any kind of electrical appliance
- Reliable and silent working with all kind of loads
- Outstanding overload capabilities
- Stand-by level adjustable over a large range and from a very low threshold
- 4 STEP battery charger with PFC
- Ultra-fast transfer relay
- High efficiency
- Full internal protection
- Ultra-fast regulation
- Microprocessor controlled

Norm E certification

The XPC 1400-12, XPC 2200-24, C 1600-12 and C 2600-24 are certified to the ECE-R 10 norm.

Compact Series	Output power P30/Pnom	Battery voltage	AC voltage	Charge current	Transfer current	Solar option (-S)
XPC 1400-12	1400 VA / 1100 VA	12 Vdc	230 Vac*	0 - 45 A	16 A	30 A
XPC 2200-24	2200 VA / 1600 VA	24 Vdc	230 Vac*	0 - 37 A	16 A	30 A
XPC 2200-48	2200 VA / 1600 VA	48 Vdc	230 Vac*	0 - 20 A	16 A	20 A
C 1600-12	1600 VA / 1300 VA	12 Vdc	230 Vac	0 - 55 A	16 A	30 A
C 2600-24	2600 VA / 2300 VA	24 Vdc	230 Vac	0 - 55 A	16 A	30 A
C 4000-48	4000 VA / 3500 VA	48 Vdc	230 Vac	0 - 50 A	16 A	20 A

* For the 120Vac/60Hz version, -01 is added to the model designation
Complete technical specifications on page 37

Optional built-in solar charge controller (-S) Simple and robust hybrid system

Compact or XP-Compact series inverter/charger with built in PWM solar charger allows for a simple stand-alone solar/diesel hybrid system. Compact, efficient, robust and delivered with battery cables. It is a cost effective choice for small solar hybrid systems.

12V/24V model => solar charge controller: 30A
48V model => solar charge controller: 20A

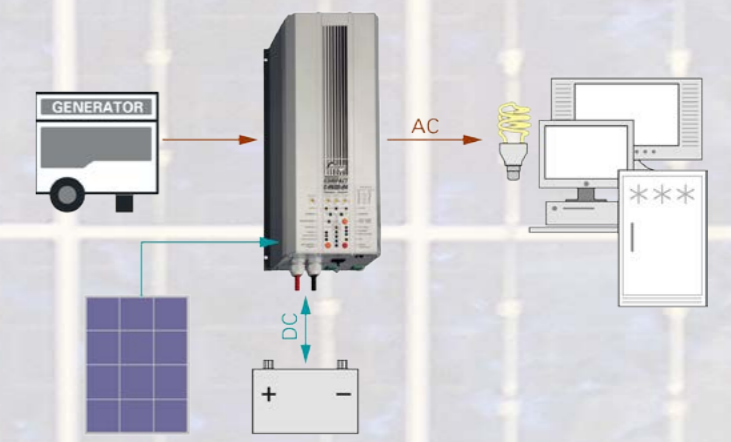

Multifunction programmable auxiliary relay

The 16A potential free contact can be programmed according to the user wishes. It reacts according to battery levels, as well as to the system status (alarm conditions, presence of public grid or sunlight...), and can be used for many diverse applications

such as:

- 1 Load shedding according to battery status
- 2 Alarm signalization or start of genset according to battery status or power output
- 3 Conditional connection to AC source to increase self consumption of renewable energy

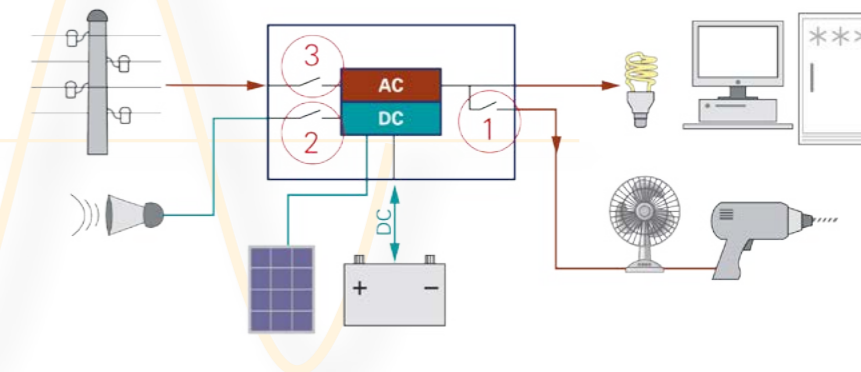

Accessories

		XP COMPACT	COMPACT
	RCC-01 The remote control provides state of the system displayed by LED and remote programming* (supplied with a 20m cable). *compulsory for the programming of the XP Compacts	•	•
	CT-35 This temperature sensor adapts charge levels to the battery's temperature variations (supplied with 3m cable).	•	•
	ARM-01 The Auxiliary relay module equipped with 3 programmed relays and a fourth one which is like the inverter-charger's auxiliary contact. This module allows the Solsafe system to be implemented (see page 11).	•	•
	CFC-01 This cover provides additional connection protection by means of glands.	•	•
	C-IP22 Cover for a protection against intrusions or projections, installed after the mounting of the device. It extends the protection index of the XP Compacts and Compacts from IP 20 to IP 22.	•	•

Sine wave inverters

AJ Series

The AJ range consists of sine wave inverter that convert battery voltage into utility quality 230Vac* which can be used with all usual electrical appliances.

Its proven reliability and outstanding performance make it the optimal solution for many applications. Delivered with battery and AC cables it is a true «plug and forget solution».

Main features

- High and steady efficiency
- Outstanding overload capabilities
- Digital regulation and control by microprocessor
- Electrical supply to any type of appliance
- Full internal protection
- Battery lifetime optimization (B.L.O.) function
- Supplied with battery and AC cables

E₂₄ Norm E certification

The AJs in 12 and 24Vdc are certified to the ECE-R 10 norm.



AJ
AJ 275-12
AJ 350-24
AJ 400-48



AJ
AJ 500-12
AJ 600-24
AJ 700-48



AJ
AJ 1000-12
AJ 1300-24



AJ
AJ 2100-12
AJ 2400-24



AJ Series	Output power P30/Pnom	Battery voltage	Solar option (-S)
AJ 275-12 (-S)	275 VA / 200 VA	12 Vdc	10 A
AJ 350-24 (-S)	350 VA / 300 VA	24 Vdc	10 A
AJ 400-48 (-S)	400 VA / 300 VA	48 Vdc	10 A
AJ 500-12 (-S)	500 VA / 400 VA	12 Vdc	15 A
AJ 600-24 (-S)	600 VA / 500 VA	24 Vdc	15 A
AJ 700-48 (-S)	700 VA / 500 VA	48 Vdc	15 A
AJ 1000-12 (-S)	1000 VA / 800 VA	12 Vdc	25 A
AJ 1300-24 (-S)	1300 VA / 1000 VA	24 Vdc	25 A
AJ 2100-12 (-S)	2100 VA / 2000 VA	12 Vdc	30 A
AJ 2400-24 (-S)	2400 VA / 2000 VA	24 Vdc	30 A

Battery Lifetime Optimizer:
With this activable function B.L.O. the AJ inverters offer an advanced protection of the battery, by a smart management of low voltage disconnection (LVD)

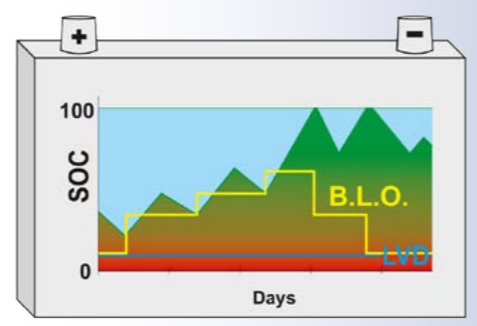

Rural electrification (Solar Home System)

AJ series inverters for rural electrification provide excellence that benefit the development of remote areas and populations. Choosing AC for rural electrification systems improves simplicity, reliability and cost savings. Indeed, compared with a DC system, one with an inverter that supplies loads in AC, is often more efficient for systems with 100W of solar power or more. The AJ series is, due to its overload capability and to its very reliable stand-by system adjustable from 2W, the most suitable range of inverters to meet the technical and economic requirements of rural electrification projects.



Solar Home System with AJ

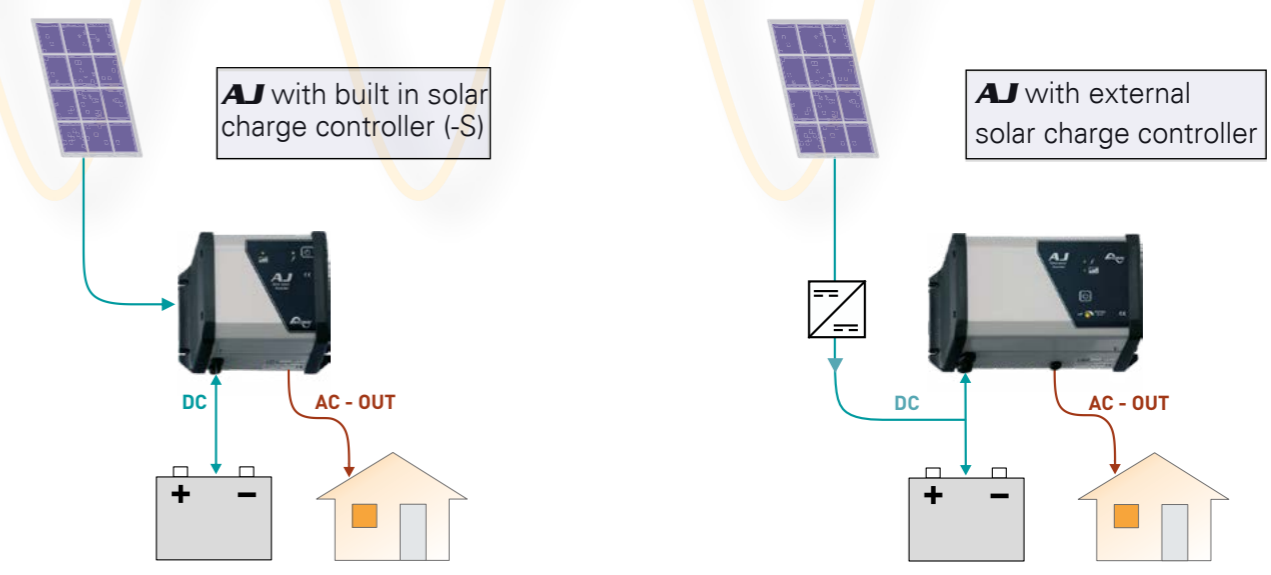

Option built-in solar charge controller

For a complete solar system! The AJ series can be supplied with an optional integrated PWM solar charge controller, making the inverter an "all in one" device for a solar home system.

Accessories

	<p>JT8 Remote control: (supplied with a 5m cable) For AJ 1000-12 and bigger model. Enables the control (ON/OFF) and the status display of the inverter: On, Standby, temporary Off</p>	<p>NOTE: For all other units from AJ275 to AJ700 its special version with remote control feature is available through a 3,2mm connector jack with 2 poles with the following 3 options: RCM-01: inverter ON when contact is closed RCM-02: inverter ON when voltage is across contacts RCM-03: inverter is ON when contact is open</p>	
--	---	--	--

For the 120Vac/60HZ version, -01 is added to the model designation
Complete technical specifications on pages 38-39

Battery chargers

DC/DC converters

Applications



MBC Series

The MBC chargers enable battery charging from an AC voltage supply source (genset, public grid, shorepower, etc.). These chargers are also watertight and therefore specially designed for outdoor applications (IP 65).

Main features

- Universal input voltage
- Charge of lead acid batteries with liquid or gelled (GEL) electrolyte
- Protection against battery overcharge

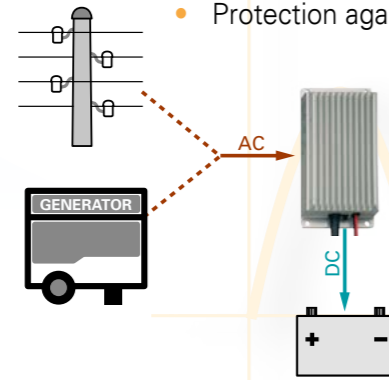

Applications



MDCI and MDC Series

The DC/DC converters type MDCI and MDC are used, depending on the model, either to step up or to step down a DC voltage. The MDCI range converters are electrically isolated.

Main features

- High efficiency
- Low consumption
- Protection against short-circuit, overheating overvoltage and reverse polarity
- Great stability of the output voltage for a more reliable system



MBC Series	Battery voltage	Input voltage	Output current	Output
MBC 12-06/1	12 Vdc	230 Vac ±15 %	6 A	1
MBC 12-15/1	12 Vdc	230 Vac ±15 %	15 A	1
MBC 24-03/1	24 Vdc	230 Vac ±15 %	3 A	1
MBC 24-08/1	24 Vdc	230 Vac ±15 %	8 A	1
MBC 24-15/1	24 Vdc	230 Vac ±15 %	15 A	1
MBC 24-32/1	24 Vdc	230 Vac ±15 %	32 A	1

Complete technical specifications on page 40

MDCI Series	Power	Input variant	Output variant	Output Current	Isolated
MDCI 100	100 W	A/B/C/D	12.5/24 Vdc	8/4 A	Yes
MDCI 200	200 W	A/B/C/D	12.5/24 Vdc	16.5/8 A	Yes
MDCI 360	360 W	A/B/C/D	12.5/24 Vdc	30/15 A	Yes
MDCI 360 A24 Charger	360 W	A	24 Vdc	15 A	Yes

A = 9-18Vdc B = 20-35Vdc C = 30-60Vdc D = 60-120Vdc (ex. MDCI 200 D24)

MDC Series	Power	Input voltage	Output voltage	Output Current	Isolated
MDC 1224-7	170 W	9-18 Vdc	24 Vdc	7 A	No
MDC 2412-5	65 W	18-35 Vdc	13.2 Vdc	5 A	No
MDC 2412-8	105 W	18-35 Vdc	13.2 Vdc	8 A	No
MDC 2412-12	160 W	20-35 Vdc	13.2 Vdc	12 A	No
MDC 2412-20	275 W	20-35 Vdc	13.8 Vdc	20 A	No
MDC 2412-30	415 W	20-35 Vdc	13.8 Vdc	30 A	No

Complete technical specifications on page 40

The MDC 2412-20 and 2412-30, as well as the MDCI 360 A24 "Charger" can also be used to charge a battery.



MOSFET battery splitters

Applications



MBI Series

The MBI MOSFET battery splitters supply current from the charger or alternator to several batteries. They generate an insignificant voltage drop. All batteries are thus charged at the same time, and therefore will not charge or discharge each other.

MBI Series	Input	Charge current	Charge input	Outputs
MBI 100/2	12/24 Vdc	100 A	1	2
MBI 150/2	12/24 Vdc	150 A	1	2
MBI 100/3	12/24 Vdc	100 A	1	3
MBI 150/3	12/24 Vdc	150 A	1	3
MBI 200/3	12/24 Vdc	200 A	1	3
MBI 2-100/3	12/24 Vdc	100 A	2	3

Complete technical specifications on page 41

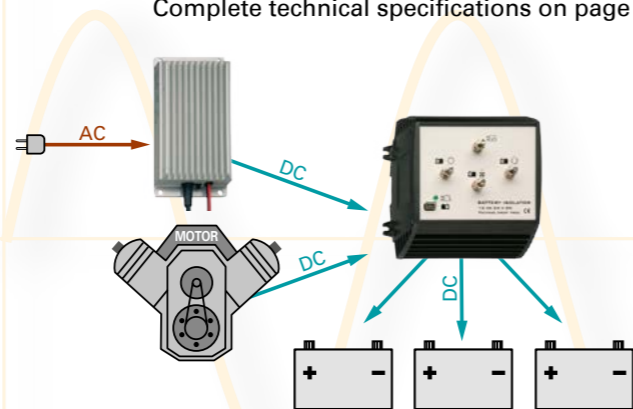

Main features

- Automatic adjustment to the batteries voltage
- Possible charge of the battery from an alternator
- Voltage drop < 0.4V at 100 Amp
- Suitable for electronic alternators

Battery separators

Applications



MBR Series

The MBR battery separators allow to supply the auxiliary battery or the appliances, as soon as the main battery voltage is high enough.

MBR Series	Battery voltage	Charge current	Batteries
MBR 12/24-100	12/24 Vdc	100 A	2
MBR 12/24-160	12/24 Vdc	160 A	2
MBR 12/24-500	12/24 Vdc	500 A	2

Complete technical specifications on page 41

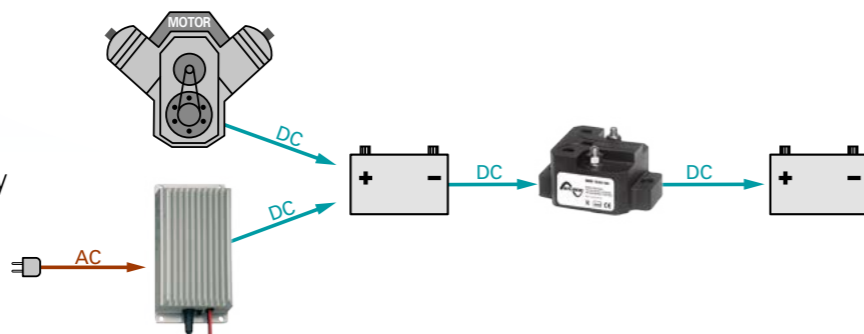

Main features

- Insignificant voltage drop
- Protects the auxiliary battery from any overvoltage

Battery protection

Applications



MBW Series

The Battery Watch protects the battery from an excessive discharge and also the consumers in case of overvoltage.

Main features and performances

- Programmed Connection and disconnection voltages by jumpers
- MOSFET switches, therefore no sparks
- Alarm output to indicate excessive voltage drops

MBW Series	Maximum current	Operating voltage range (Vdc)
MBW 40	40 A	6-35 Vdc
MBW 60	60 A	6-35 Vdc
MBW 200	200 A	8-32 Vdc

Complete technical specifications on page 42

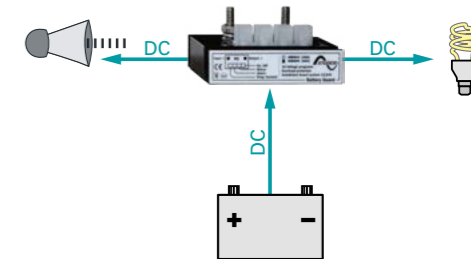

Battery monitoring

Applications



SBM-02

The SBM-02 is a highly accurate battery monitor with a data history memory. It is supplied together with a 500A/50mV shunt. This device is designed for 12 and 24V batteries. The optional SBM-PS-02 voltage pre-scaler extends the use of the SBM-01 to 27-175V batteries.

Main features and performances

- Digital display of the 6 most important parameters of a DC power system:
 1. Battery voltage (V)
 2. Current (A)
 3. Consumed Ampere-hours (Ah)
 4. State-of-charge (%)
 5. Time-to-go (h:m)
 6. Temperature (°C or °F)

Optional accessories

- Connection kit, type SBM-CAB-20, including 20m of twisted pair cable (3 x 2 x 0.5mm²) and 2 fuseholders
- Communication kit, type SBM-COM, including RS232 interface box, 1.8m of 9p DSUB serial cable and software
- Communication kit, type SBM-COM-USB, including USB interface box, 1.8m of USB cable and software.
- Temperature kit, type SBM-TEMP-20, with a temperature sensor and 20 m cable
- Shunt 1200A / 50mV, type SH-1200-50, for battery monitoring in large system

VarioTrack Series



Model	VT-65			VT-80		
Electrical characteristics PV array side						
At nominal battery voltage	12 V	24 V	48 V	12 V	24 V	48 V
Maximum solar power recommended (@STC)	1000 W	2000 W	4000 W	1250 W	2500 W	5000 W
Maximum solar open circuit voltage	80 V	150 V		80 V	150 V	
Maximum solar functional circuit voltage	75 V	145 V		75 V	145 V	
Minimum solar functional circuit voltage	Above battery voltage					
Electrical characteristics battery side						
Maximum output current	65 A			80 A		
Nominal battery voltages	Automatic / manual set to 12, 24 or 48 V					
Operating voltage range	7 - 68 V					
Performances of the device						
Power conversion efficiency (in a 48 V typical-system)	> 99 %					
Maximum stand-by self-consumption (48 V)	25 mA > 1.2 W					
Maximum stand-by self-consumption (24 V)	30 mA > 0.8 W					
Maximum stand-by self-consumption (12 V)	35 mA > 0.5 W					
Charging stages	4 stages: Bulk, Absorption, Float, Equalization					
Battery temperature compensation (available with accessory BTS-01)	-3 mV / °C / cell (25°C ref) default value adjustable -8 to 0 mV / °C					
Electronic protections						
PV reverse polarity	Up to -150 V					
Battery reverse polarity	Up to -150 V					
Battery overvoltage	Up to 150 V					
Over temperature	Protected					
Reverse current at night	Prevented by relays					
Environment						
Operating ambient temperature range	-20 to 55°C					
Humidity	100 %					
Ingress protection of enclosures	IP54, IEC/EN 60529:2001					
Mounting location	indoor					
General data						
Warranty	5 years					
ISO Certification	9001:2008 / 14001:2004					
Weight	5.2 kg			5.5 kg		
Dimensions h/w/l [mm]	120 / 220 / 310			120 / 220 / 350		
Parallel operation (separated PV arrays)	Up to 15 devices					
Max wire size	35 mm ²					
Glands	M 20 x 1,5					
Communication						
Network cabling	STUDER communication BUS					
Remote control & Communication	RCC-02/-03, Xcom-232i / Xcom-LAN / Xcom-GSM / Xcom-SMS					
Menu languages	English / French / German / Spanish					
Data logging	With RCC-02/03, Xcom-232i on SD card · One point every minute					
Accordance to standards						
CE compliant	EMC 2004/108/EC · LV 2006/95/EC · RoHS 2011/65/EU					
Safety	IEC/EN 62109-1:2010					
EMC (Electro Magnetic Compatibility)	IEC/EN 61000-6-3:2011 · IEC/EN 61000-6-1:2005					
Accessories						
Remote control RCC-02 or RCC-03	•			•		
Module Xcom-232i	•			•		
Communication sets Xcom-LAN / Xcom-GSM / Xcom-SMS	•			•		
Battery Status Processor BSP	•			•		
2 aux. contacts module ARM-02	•			•		
Cooling Module ECF-01	•			Included		
Battery temp. sensor BTS-01 (3 m)	•			•		
Communication cable CAB-RJ45-8-2	•			•		

VarioString Series



Model	VS-70	VS-120			
Electrical characteristics PV array side					
Maximum solar power recommended (@STC)	4000 W	3500 W	3500 W	7000 W	7000 W
Maximum current	13 A	13 A	13 A	26 A	13 A
Maximum solar open circuit voltage	600 V	600 V	600 V	600 V	900 V
Minimum solar functional circuit voltage	200 V	200 V	200 V	200 V	400 V
Recommended MPPT voltage	250-500 V	250-500 V	250-500 V	250-500 V	500-750 V
Electrical characteristics battery side					
Maximum output current	70 A	60 A	60 A	120 A	
Nominal battery voltages	48 V				
Operating voltage range	38 - 68 V				
Battery grounding possibility	Battery + or battery -				
Performances of the device					
Maximum efficiency	> 98 %				
MPPT efficiency	> 99.8 %				
Maximum stand-by self-consumption (48 V)	< 20 mA (1 W)	< 25 mA (1.25 W)			
Charging stages	4 stages: Bulk, Absorption, Float, Equalization				
Battery temperature compensation (with accessory BTS-01)	-3 mV / °C / cell (25°C ref) default value adjustable -8 to 0 mV / °C				
Electronic protections					
PV reverse polarity	•				
Battery overvoltage	Up to max 80 V				
Over temperature	•				
Reverse current at night	•				
Galvanic isolation	•				
PV grounding possibility	PV + , PV - , floating				
Ground fault Protection	Programmable				
Environment					
Operating ambient temperature range	-20 to 55°C				
Humidity	100 %	maximum 95 %, non-condensing			
Ingress protection of enclosures, IEC/EN 60529:2001	IP54	IP20			
Mounting location	indoor				
General data					
Warranty	5 years				
ISO Certification	9001:2008 / 14001:2004				
Weight	5.51 kg	7.5 kg			
Dimensions h/w/l [mm]	120 / 220 / 350	133 / 322 / 466			
Solar generation connection (6mm ²)	SUNCLIX™ (Phoenix Contact Tool Free)				
Parallel operation (separated PV arrays)	Up to 15 devices				
Max wire size	35 mm ²	70 mm ²			
Glands	M 20 x 1,5	2 x PG21			
Communication					
Network cabling	STUDER communication BUS				
Remote control & Communication	RCC-02/-03, Xcom-232i / Xcom-LAN / Xcom-GSM / Xcom-SMS				
Menu languages	English / French / German / Spanish				
Data logging	With RCC-02/03, Xcom-232i on SD card · One point every minute				
Accordance to standards					
CE compliant	EMC 2004/108/EC · LV 2006/95/EC · RoHS 2011/65/EU				
Safety	IEC/EN 62109-1:2010				
EMC (Electro Magnetic Compatibility)	IEC/EN 61000-6-3:2011 · IEC/EN 61000-6-1:2005				
Accessories					
Remote control RCC-02 or RCC-03	•		•		
Module Xcom-232i	•		•		
Communication sets Xcom-LAN / Xcom-GSM / Xcom-SMS	•		•		
Battery Status Processor BSP	•		•		
2 aux. contacts module ARM-02	•		•		
Battery temp. sensor BTS-01 (3 m)	•		•		
Communication cable CAB-RJ45-8-2	•		•		

Xtender Series



Model	XTS 900-12	XTS 1200-24	XTS 1400-48	XTM 1500-12	XTM 2000-12	XTM 2400-24	XTM 2600-48	XTM 3500-24	XTM 4000-48	XTH 3000-12	XTH 5000-24	XTH 6000-48	XTH 8000-48	
Inverter														
Nominal battery voltage	12 Vdc	24 Vdc	48 Vdc	12 Vdc	24 Vdc	48 Vdc	24 Vdc	48 Vdc	12 Vdc	24 Vdc	48 Vdc			
Input voltage range	9.5 - 17 Vdc	19 - 34 Vdc	38 - 68Vdc	9.5 - 17 Vdc	19 - 34 Vdc	38 - 68 Vdc	19 - 34 Vdc	38 - 68 Vdc	9.5 - 17 Vdc	19 - 34 Vdc	38 - 68 Vdc			
Continuous power @ 25°C	650**/500VA	800**/650VA	900**/750VA	1500 VA	2000 VA	2000 VA	3000 VA	3500 VA	2500 VA	4500 VA	5000 VA	7000 VA		
Power 30 min. @ 25°C	900**/700VA	1200**/1000VA	1400**/1200VA	1500 VA	2000 VA	2400 VA	2600 VA	3500 A	4000 VA	3000 VA	5000 VA	6000 VA	8000 VA	
Power 5 sec. @ 25°C	2.3 kVA	2.5 kVA	2.8kVA	3.4 kVA	4.8 kVA	6 kVA	6.5 kVA	9 kVA	10.5 kVA	7.5 kVA	12 kVA	15 kVA	21 kVA	
Maximum load	Up to short-circuit													
Asymmetric load	Up to Pcont.													
* Load detection (stand-by)	2 to 25 W													
Cos φ	0.1-1													
Maximum efficiency	93 %	93 %	93 %	93 %	94 %	96 %	94 %	96 %	93 %	94 %	96 %			
Consumption OFF/Stand-by/ON [W]	1.1 / 1.4 / 7	1.2 / 1.5 / 8	1.3 / 1.6 / 8	1.2 / 1.4 / 8	1.2 / 1.4 / 10	1.4 / 1.6 / 9	1.8 / 2 / 10	1.4 / 1.6 / 12	1.8 / 2.1 / 14	1.2 / 1.4 / 14	1.4 / 1.8 / 18	1.8 / 2.2 / 22	1.8 / 2.4 / 30	
* Output voltage	Pure sine wave 230 Vac (± 2 %) / 120 Vac ⁽¹⁾													
* Output frequency	Adjustable 45 - 60 Hz ⁽¹⁾ ± 0.05 % (crystal controlled)													
Harmonic distortion	< 2 %													
Overload and short-circuit protection	Automatic disconnection with 3 time restart attempt													
Overheat protection	Warning before shut-off - with automatic restart													
Battery charger														
* Charge Characteristic	6 steps: Bulk, Absorption, Floating, Equalization, reduced floating, periodic absorption Number of steps, thresholds, end current and times completely adjustable with the RCC-02/-03													
* Maximum charging current	35 A	25 A	12 A	70 A	100 A	55 A	30 A	90 A	50 A	160 A	140 A	100 A	120 A	
* Temperature compensation	With BTS-01 or BSP 500/1200													
Power Factor Correction (PFC)	EN 61000-3-2													
General data														
* Input voltage range	150 to 265 Vac / 50 to 140 Vac ⁽¹⁾													
Input frequency	45 to 65 Hz													
Input current max. (transfer relay) / Output current max.	16 Aac / 20 Aac			50 Aac / 56 Aac						50Aac/80Aac				
Transfer time	< 15 ms													
Multifunction contacts	Module ARM-02 with 2 contacts, in option			2 independent contacts (potential free 3 points, 16 Aac / 5 Adc)										
Weight	8.2 kg	9 kg	9.3 kg	15 kg	18.5 kg	16.2 kg	21.2 kg	22.9 kg	34 kg	40 kg	42 kg	46 kg		
Dimension h/w/l [mm]	110 / 210 / 310			133 / 322 / 466						230/300/500				
Protection index	IP54			IP20										
Conformity	Directive EMC 2004/108/EC: EN 61000-6-1, EN 61000-6-3, EN 55014, EN 55022, EN 61000-3-2, EN 62040-2 Low voltage directive 2006/95/EC: EN 62040-1-1, EN 60950-1, EN 50178, EN 62109-1													
Operating temperature range	-20 to 55°C													
Relative humidity in operation	100 %			95% without condensation										
Ventilation	Optional cooling module ECF-01			Forced from 55°C										
Acoustic level	< 40 dB / < 45 dB (without/with ventilation)													
Warranty	5 years													
ISO Certification	9001:2008 / 14001:2004													
Accessories														
Remote control RCC-02 or RCC-03	•	•	•	•	•	•	•	•	•	•	•	•	•	
Module Xcom-232i	•	•	•	•	•	•	•	•	•	•	•	•	•	
Communication sets Xcom-LAN / Xcom-GSM / Xcom -SMS	•	•	•	•	•	•	•	•	•	•	•	•	•	
Battery Status Processor BSP	•	•	•	•	•	•	•	•	•	•	•	•	•	
Remote Control Module RCM-10 (3 m)	•	•	•	•	•	•	•	•	•	•	•	•	•	
2 aux. contacts module ARM-02	•	•	•											
Cooling Module ECF-01	•	•	•											
Battery temp. sensor BTS-01 (3 m)	•	•	•	•	•	•	•	•	•	•	•	•	•	
Communication cable for 3ph and // CAB-RJ45-8-2	•	•	•	•	•	•	•	•	•	•	•	•	•	
Mounting frame X-Connect										•	•	•	•	

* Adjustable with the RCC-02/-03

** These features are valid only when using the cooling module ECF-01.

⁽¹⁾ With -01 at the end of the reference, means 120V/60Hz. Available for all Xtenders except XTH 8000-48

Data may change without any notice

COMPACT Series



Model	XPC 1400-12	XPC 2200-24	XPC 2200-48	C 1600-12	C 2600-24	C 4000-48
Inverter						
Nominal battery voltage	12 Vdc	24 Vdc	48 Vdc	12 Vdc	24 Vdc	48 Vdc
Input voltage range	9.5 - 16 Vdc	19 - 32 Vdc	38 - 64 Vdc	9.5 - 16 Vdc	19 - 32 Vdc	38 - 64 Vdc
Continuous power @ 25°C	1100 VA	1600 VA	1600 VA	1300 VA	2300 VA	3500 VA
Power 30 min. @ 25°C	1400 VA	2200 VA	2200 VA	1600 VA	2600 VA	4000 VA
Power 5 sec. @ 25°C	3 x Pnom					
Maximum power	Up to short-circuit					
Maximum asymmetric load	Up to Pcont.					
Stand-by adjustment	1 to 25 W					
Cos φ	0.1 - 1					
Maximum efficiency	94 %	95 %	94 %	94 %	95 %	95 %
Consumption OFF/Stand-by/ON [W]	0.5 / 0.6 / 4	0.8 / 0.9 / 7	1.2 / 1.3 / 7	0.5 / 0.6 / 6	0.8 / 0.9 / 9	1.2 / 1.4 / 12
Output voltage	Sine wave 230 Vac (± 5 %) (XPC also available in 120 Vac)					
Output frequency	50 Hz ± 0.05 % (crystal controlled)					
Total harmonic distortion	< 4 %	< 2 %				
Overload and short-circuit protection	Automatic disconnection with 3 time restart attempt					
Overheat protection	Acoustic warning before shut-off - with automatic restart					
Battery charger (4 STEP) I-U-Uo-Equalize (every 25 cycles)						
Charging current adjustable	0 - 45 Adc	0 - 37 Adc	0 - 20 Adc	0 - 55 Adc	0 - 50 Adc	0 - 50 Adc
Input current balance adjustment	Not available			1 - 16 A		
Maximum input voltage	265 Vac					
Input AC voltage range	Adjustable threshold from 150 to 230 Vac (XPC also available in 120 Vac)					
Input frequency	45 - 65 Hz					
Power Factor Correction (PFC)	EN 61000-3-2					
Battery control (thresholds and times adjustable by the user)						
Absorption time	0-4 h					
End charge cycle voltage*	14.4 Vdc	28.8 Vdc	57.6 Vdc	14.4 Vdc	28.8 Vdc	57.6 Vdc
Floating voltage*	13.6 Vdc	27.2 Vdc	54.4 Vdc	13.6 Vdc	27.2 Vdc	54.4 Vdc
Equalization time*	0-4 h					
Equalization voltage*	15.6 Vdc	31.2 Vdc	62.4 Vdc	15.6 Vdc	31.2 Vdc	62.4 Vdc
Deep-discharge protection*	10.8 Vdc	21.6 Vdc	43.2 Vdc	10.8 Vdc	21.6 Vdc	43.2 Vdc
Temperature compensation (CT-35)	-3mV / ° C / Cell					
General data						
Multifunction contact programmable	16 A - 250 Vac (potential free 3 points)					
Max. current on transfer relay	16 Aac					
Transfer time	< 40 ms					
Weight	11.7 kg	12.6 kg	16 kg	17.1 kg	29.4 kg	
Dimensions h/w/l [mm]	124 / 215 / 410		124 / 215 / 480		124 / 215 / 670	
Protection index	IP20 (IP22 with top cover C-IP22)					
Certification ECE-R 10 (E24)	•	•	Not available	•	•	Not available
EC conformity	EN 61000-6-1, EN 61000-6-3, EN 55014, EN 55022, EN 61000-3-2, EN 50091-2 Low voltage directive 2006/95/EC: EN 62040-1-1, EN 60950-1					
Operating temperature range	-20°C to +55°C					
Relative humidity in operation	95 % without condensation					
Ventilation	From 45°C					
Acoustic level	< 40 dB / < 45 dB (without/with ventilation)					
Warranty	5 years					
ISO Certification	9001:2008 / 14001:2004					
Option solar charger (4 stages)						
Maximum PV open circuit voltage (V)	25 Vdc	45 Vdc	90 Vdc	25 Vdc	45 Vdc	90 Vdc
Maximum charge current (A)	30 Adc	30 Adc	20 Adc	30 Adc	30 Adc	20 Adc
Charging curve	I-U-Uo-Equalize (every 25 cycles)					
Accessories						
RCC-01 Remote control	•					
CT-35 Temperature sensor	•					
ARM-01 Auxiliary relay module	•					
CFC-01 Cover	•					
C-IP22 Cover	•					

* Factory settings
Data may change without any notice

AJ Series



Model	AJ 275-12	AJ 350-24	AJ 400-48	AJ 500-12	AJ 600-24	AJ 700-48	
Inverter							
Nominal battery voltage	12 Vdc	24 Vdc	48 Vdc	12 Vdc	24 Vdc	48 Vdc	
Input voltage range	10.5 – 16 Vdc (24 Vdc max.)	21 – 32 Vdc (44 Vdc max.)	42 – 64 Vdc (64 Vdc max.)	10.5 – 16 Vdc (24 Vdc max.)	21 – 32 Vdc (44 Vdc max.)	42 – 64 Vdc (64 Vdc max.)	
Continuous power @ 25°C	200 VA	300 VA	300 VA	400 VA	500 VA	500 VA	
Power 30 min. @ 25°C	275 VA	350 VA	400 VA	500 VA	600 VA	700 VA	
Power 5 min. @ 25°C	350 VA	500 VA	600 VA	575 VA	675 VA	900 VA	
Power 5 sec. @ 25°C	450 VA	650 VA	1000 VA	1000 VA	1200 VA	1400 VA	
Asymmetric load	150 VA	150 VA	200 VA	250 VA	300 VA	300 VA	
Max. efficiency (%)	93 %	94 %	94 %	93 %	94 %	94 %	
Cos φ max.	0.1 – 1 up to 200 VA	0.1 – 1 up to 300 VA	0.1 – 1 up to 300 VA	0.1 – 1 up to 400 VA	0.1 – 1 up to 500 VA	0.1 – 1 up to 500 VA	
Detection of the load	2 W only with the solar option -S			Adjustable: 1 to 20W			
Short-circuit current AC 2 sec.	2.3 Aac (4.6 Aac*)	3.2 Aac (6.4 Aac*)	4.6 Aac (9.2 Aac*)	5.2 Aac (10.4 Aac*)	5.7 Aac (11.4 Aac*)	7 Aac (14 Aac*)	
Output voltage	Sine wave 230 Vac (120 Vac*) ±5 %						
Frequency	50 Hz (60 Hz*) ± 0.05 % (crystal controlled)						
Distortion THD (resistive load)	< 5 % (@ Pnom.)						
Consumption Stand-by	0.3 W**	0.5 W**	1.1 W**	0.4 W	0.6 W	1.5 W	
Consumption «ON» no load	2.4 W	3.5 W	5.2 W	4.6 W	7.2 W	12 W	
Overheat protection (±5°C)	Shut down @ 75°C - Auto-restart @ 70°C						
Overload and short circuit protection	Automatic disconnection with 2 time restart attempt						
Reverse polarity protection as internal fuse	60 A	40A	25 A	120 A	90 A	60 A	
Deep discharge battery protection	Shut off @ 0.87 x Unom - Automatic restart @ Unom						
Max. battery voltage	Shut off @ >1.33 x Unom - Automatic restart @ < Umax						
Acoustic alarm	Before low battery or overheating disconnection						
General data							
Weight	2.4 kg	2.6 kg			4.5 kg		
Dimensions h/w/l [mm]	142 / 163 / 84			142 / 240 / 84			
Protection index IP	IP 30 conforms to DIN 40050						
Certification ECE-R 10 (E24)	•	•	Not available	•	•	Not available	
EC conformity	EN 61000-6-1, EN 61000-6-3, EN 55014, EN 55022, EN 60950-1						
Operating temperature	-20°C to +50°C						
Relative humidity in operation	95 % without condensation						
Ventilation forced	From 45°C ± 5°C						
Acoustic level	< 45 dB (with ventilation)						
Warranty	5 years						
ISO Certification	9001:2008 / 14001:2004						
Approximate correction of Pnom	-1.5 % / °C from +25°C						
Recommended battery capacity	> 5 x Pnom/Unom (recommended value in Ah)						
Length cables (Battery/AC out)	1.2 m / 1 m			1.5 m / 1 m			
Options							
	AJ 275-12-S	AJ 350-24-S	AJ 400-48-S	AJ 500-12-S	AJ 600-24-S	AJ 700-48-S	
Solar regulator	Voltage max.	25 Vdc	45 Vdc	90 Vdc	25 Vdc	45 Vdc	
	Current max.	10 Adc			15 Adc		
	Principle	Floating 3 stages (I/U/UO)					
	Absorption voltage	14.4 Vdc	28.8 Vdc	57.6 Vdc	14.4 Vdc	28.8 Vdc	57.6 Vdc
	Floating voltage	13.6 Vdc	27.2 Vdc	54.4 Vdc	13.6 Vdc	27.2 Vdc	54.4 Vdc
Plug for remote control (RCM)	•	•	•	•	•	•	
Accessories							
JT8 Remote control	•	•	•	•	•	•	

* 120Vac/60Hz on request
** Standby with solar option -S

AJ Series



Model	AJ 1000-12	AJ 1300-24	AJ 2100-12	AJ 2400-24	
Inverter					
Nominal battery voltage	12 Vdc	24 Vdc	12 Vdc	24 Vdc	
Input voltage range	10.5 – 16 Vdc (24 Vdc max.)	21 – 32 Vdc (44 Vdc max.)	10.5 – 16 Vdc (20 Vdc max.)	21–32 Vdc (40 Vdc max.)	
Continuous power @ 25°C	800 VA	1000VA	2000 VA	2000 VA	
Power 30 min. @ 25°C	1000 VA	1300 VA	2100 VA	2400 VA	
Power 5 min. @ 25°C	1200 VA	2000 VA	2450 VA	2800 VA	
Power 5 sec. @ 25°C	2200 VA	2800 VA	5000 VA	5200 VA	
Asymmetric load	500 VA	600 VA	1000 VA	1200 VA	
Max. efficiency (%)	93 %	94 %	92 %	94%	
Cos φ max.	0.1 – 1 up to 800 VA	0.1 – 1 up to 1000 VA	0.1 – 1 up to 2000 VA	0.1 – 1 up to 2000 VA	
Detection of the load	Adjustable: 1 to 20 W				
Short-circuit current AC 2 sec.	10 Aac (20 Aac*)	13 Aac (26 Aac*)	26 Aac (52 Aac*)	30 Aac (60 Aac*)	
Output voltage	Sine wave 230 Vac (120 Vac*) ±5%				
Frequency	50 Hz (60 Hz*) ± 0.05 % (crystal controlled)				
Distortion THD (resistive load)	< 5 % (@ Pnom. & Uin nom.)			< 3 % (@ Pnom & Uin nom.)	
Consumption Stand-by	0.7 W	1.2 W	0.7 W	1.2 W	
Consumption «ON» no load	10 W	13 W	16 W	16 W	
Overheat protection (±5°C)	Shut down @ 75°C - Auto-restart @ 70°C				
Short circuit protection	Automatic disconnection with 2 time restart attempt				
Reverse polarity protection by internal fuse	125 A	100 A	Not protected	150 A	
Deep discharge battery protection	Shut off @ 0.87 x Unom - Automatic restart @ Unom				
Max. battery voltage	Shut off @ >1.33 x Unom - Automatic restart @ < Umax				
Acoustic alarm	Before low battery or overheating disconnection				
General data					
Weight	8.5 kg		19 kg	18 kg	
Dimensions h/w/l [mm]	142 / 428 / 84		273 / 399 / 117		
Protection index IP	IP 30 conforms to DIN 40050		IP 20 conforms to DIN 40050		
Certification ECE-R 10 (E24)	•	•	•	•	
EC conformity	EN 61000-6-1, EN 61000-6-3, EN 55014, EN 55022, EN 60950-1				
Operating temperature	-20°C to +50°C				
Relative humidity in operation	95 % without condensation				
Ventilation forced	From 45°C ± 5°C				
Acoustic level	< 45 dB (with ventilation)				
Warranty	5 years				
ISO Certification	9001:2008 / 14001:2004				
Approximate correction of Pnom	-1.5 % / °C from +25°C				
Recommended battery capacity	> 5 x Pnom/Unom (recommended value in Ah)				
Length cables (Battery/IAC out)	1.5 m / 1 m		1.7 m / 1 m		
Options					
	AJ 1000-12-S	AJ 1300-24-S	AJ 2100-12-S	AJ 2400-24-S	
Solar regulator	Voltage max.	25 Vdc	45 Vdc	25 Vdc	
	Current max.	25 Adc		30 Adc	
	Principle	Floating 3 stages (I/U/UO)			
	Absorption voltage	14.4 Vdc	28.8 Vdc	14.4 Vdc	28.8 Vdc
	Floating voltage	13.6 Vdc	27.2 Vdc	13.6 Vdc	27.2 Vdc
Accessories					
JT8 Remote control	•	•	•	•	

* 120Vac/60Hz on request

MBC Series



Model	MBC 12-06/1	MBC 12-15/1	MBC 24-03/1	MBC 24-08/1	MBC 24-15/1	MBC 24-32/1
Battery voltage (Vdc)	12	12	24	24	24	24
Input voltage (Vac)	230 ±15 % (40 - 60 Hz)					
Charge voltage (boost) (Vdc)	14.4	14.4	28.8	28.8	28.8	28.8
Charge voltage (float) (Vdc)	13.8	13.8	27.6	27.6	27.6	27.6
Output (A)	6	15	3	8	15	32
Cooling	Heat sink					
Outputs	1					
Efficiency	> 85 %					
Ambient temp. range	-25 to 50°C					
Dimensions L/W/H [mm]	155 / 80 / 36	195 / 100 / 47	155 / 80 / 36	195 / 100 / 46	193 / 99 / 46	158 / 245 / 47.5
Weight (kg)	0.9	1.8	0.9	1.8	1.8	3.8
Switch to Floating mode (A)	0.2	0.8	0.2	0.4	1.5	3.5
Secondary fuse (A)	7.5	20	7.5	15	20	40
Input wired	•	•	•	•	•	•
Output wired	•	•	•	•	•	•
Warranty	2 years					

MDCI and MDC Series



MDCI – DC/DC converter, switch-mode, isolated

Model	MDCI 100	MDCI 200	MDCI 360	MDCI 360 Charger
Power (W)	100	200	360	360
Input variants (Vdc)*	A-B-C-D	A-B-C-D	A-B-C-D	A
Output variants (Vdc/A) ± 2%	12.5 / 8-24 / 4	12.5 / 16-24 / 8	12.5 / 30-24 / 15	27.6 / 13
Output current (A)	8 / 4	16.5 / 8	30 / 15	13
Galvanic isolation	•	•	•	•
Isolation voltage (V)	400			
Efficiency @ full load (%)	> 85			
Off-load current (mA)	< 25			
Operating temperature	-20 / +45°C			
Ambiant temp. (20°) increase after 30 min. @ full load	25°C		30°C	
Cooling	Convection		Fan	
Dimensions H/W/D [mm]	49 / 88 / 152		64 / 163 / 160	
Weight (gr)	500		1400	

* A = 9-18 Vdc B = 20-35 Vdc C = 30-60 Vdc D = 60-120 Vdc

MDC –DC/DC converter, switch-mode, not-isolated

Model	MDC 1224-7	MDC 2412-5	MDC 2412-8	MDC 2412-12	MDC 2412-20	MDC 2412-30
Power (W)	170	65	105	160	275	415
Output current (A)	7	5.5	8	12	20	30
Input (Vdc)	9-18	18-35		20-35		
Output (Vdc)	24	13.2		13.8		
Efficiency @ full load (%)	90					
Off-load current (mA)	< 15	< 5		< 25		
Operating temperature	-20 / +40°C					
Ambiant temp. (20°) increase after 30 min. @ full load	30°C		20°C	30°C	33°C	
Cooling	Convection					Fan
Dimensions H/W/D [mm]	49 / 88 / 98	49 / 88 / 68	49 / 98 / 88		49 / 88 / 126	49 / 88 / 151
Weight (gr)	300	170	250	260	480	600

Common features MDCI & MDC		
Paralleling (only MDCI)	Max. 2 converters	
Humidity	Max. 95% non condensing	
Protection	Overload	Up to short-circuit
	Overheating	Output voltage reduction
	Overvoltage	Transient protection by Varistor
	Reverse polarity	Fuse
Casework	Anodized aluminium	
Connections	6.3 mm Faston	
Warranty	2 years	
Norms	EN 50081-1 (emission) EN 50082-1 (immunity) 95/54/EC (automotive directive)	

Data may change without any notice

MBI Series



MBI – Battery isolator, voltage drop free

Model	MBI 100/2 IG	MBI 150/2 IG	MBI 100/3 IG	MBI 150/3 IG	MBI 200/3 IG	MBI 2-100/3
Input nominal voltage (Vdc)	12 / 24					
Input voltage range (Vdc)	8 - 30					
Charge current max. (A)	100	150	100	150	200	100
Input number	1					
Battery banks	2		3			
Voltage drop @ 10a/20A (V)	0.05 / 0.1					
Consumption	0.24 mA @ 24 V			0.12 mA @ 12 V		
Alternator start	•	•	•	•	•	
Operating temperature (°C)	-40 / +85					
Dimensions L/H/D [mm]	146 / 85 / 92			146 / 85 / 152		
Weight (gr)	780	810	780	810	815	780
Nominal voltage 12 or 24V	Automatic detection					
Insulation to ground	> 500 V @ 60 Hz					
Warranty	2 years					
Norms	EN 50081-1 (emission) EN 50082-1 (immunity) EN 60950-1 (safety)					

MBR Series



MBR – Microprocessor controlled battery separator

Model	MBR 12/24-100	MBR 12/24-160	MBR 12/24-500
Nominal voltage (Vdc)	12/24	12/24	12/24
Charge current max. (Amp)	100	160	500
Connection threshold (Vdc) ± 2%	13.2 / 26.4	13.2 / 26.4	13.2 / 26.4
Disconnection threshold (Vdc) ± 2%	12.8 / 25.6	12.8 / 25.6	12.8 / 25.6
Battery banks	2		
Alternator start	•	•	•
Start contact for batteries paralleling		•	•
Micro switch for remote status indication			•
Dimensions L/H/D [mm]	46 / 46 / 80	46 / 93 / 96	72 / 70 / 80
Weight (gr)	110	300	417
Consumption	< 5 mA		
Protection of the auxiliary battery against overvoltage	16 / 32 Vdc		
Connection on the battery side	M6		M8
Other connections	6.3 mm Faston		
Warranty	2 years		
Norms	EN 50081-1 (emission) EN 50082-1 (immunity) Automotive Directive 95/54/CE		

Data may change without any notice

MBW Series



MBW – Battery watch

Model	MBW 40	MBW 60	MBW 200
Nominal voltage (Vdc) depends on jumpers		12/24	
Max. continuous current 5' (A)	40	60	200
Peak current (A)	120	120	480
Operating voltage range (Vdc)	6-35		8-32
Consumption (mA)	< 7		< 3
Alarm output delay	15 seconds		
Alarm output max. current (mA)	500		
Load disconnect delay	1 minute		30 secondes
Voltage level accuracy	0.2 V	2 %	0.1 V
Casework	Anodized aluminium, black		
Weight (gr)	200		580
Dimensions H/D/L [mm]	80 / 60 / 40	80 / 60 / 40	145 / 92 / 85
Battery protection	Against excessive discharge		
Users protection	Against overvoltages (16 / 32 Vdc)		Against overvoltages (15.5 / 31 Vdc)
MOSFET switches	No sparks		
Norms	EN 50081-1 (emission) EN 50082-1 (immunity) Automotive Directive 95/54/CE		EN 50081-1 (emission) Automotive Directive 95/54/CE

Jumper selectable voltage	
Disengage (V)	Engage (V)
10	11.5
10.5	12
11	13
11.5	13.8
21.5	24.5
22	25
22.5	25.5
23	26.5

SBM-02



SBM-02 – Battery monitor 12 and 24Vdc (27-175Vdc in option)

Model	SBM-02	
Supply voltage range	9 - 35 Vdc	
Consumption @ 12Vdc, without BL	9 mA	
Consumption @ 24Vdc, without BL	7 mA	
Input voltage range («Auxiliary» battery)	2 - 35 Vdc	
Input voltage range («Main» battery)	0 - 35 Vdc	
Input current range	-9999 - +9999 A	
Battery capacity range	20 - 9990 Ah	
Operating temperature range	-20 - 50°C	
Protection class	IP20 (Frontpanel IP65)	
Dimensions	Front panel	Ø 64 mm
	Body diameter	Ø 52 mm
	Total depth	79 mm

Standart equipment SBM-02
Potential free alarm contact
500A/50mV current shunt
Optional accessories
SBM-PS-02-Voltage pre-scaler 1:5 (adapting the SBM-02 to input voltage 27-175Vdc)
Connection kit, type SBM-CAB-20, including 20 m of twisted pair cable (3x2x0.5 mm2) and 2 fuseholders
Communication kit, type SBM-COM, including RS232 interface box, 1.8 m of 9p DSUB serial cable and a software
Communication kit, type SBM-COM-USB, including USB interface box, 1.8 m of USB cable and software.
Temperature kit, type SBM;-TEMP-20, with 20 m cable
Shunt 1200 A/50 mV, type SH-1200-50



STUDER

STUDER INNOTECH SA
Rue des Casernes 57
1950 Sion - Switzerland
Phone: +41 (0) 27 205 60 80
Fax: +41 (0) 27 205 60 88
info@studer-innotec.com
www.studer-innotec.com

SWISS made power